



Winnipeg

**2024  
STREET  
CUTS  
MANUAL**

*Revised 2024-04-10 by:  
Public Works - Engineering Division*

## MESSAGE FROM THE DIRECTOR

The Public Works Department under the authority of the amended *Streets By-law 1481/77* has revised many of the processes pertaining to street cuts made in the Right-of-Way. This *Street Cuts Manual* in conjunction with the *Streets By-law* and *City of Winnipeg Standard Construction Specifications* become the guiding documents to the making, maintenance and restoration of street cuts.

The goal of the new By-law amendments and the *Street Cuts Manual* is to make the process of working in the Right-of-Way more straightforward, less frustrating and easier to enforce while better protecting the public interest and safety, as well as minimizing disruptions. The *Street Cuts Manual* will be published to the City's web page annually to assist those working in the Right-of-Way.

Jim Berezowsky,

Director of Public Works

## **MISSION STATEMENT**

*The management and effective restoration of excavation in the Right-of-Way, which ensures quality and continued use of our City's street infrastructure to the satisfaction of our customer.*

## **VISION STATEMENT**

*Our Vision is to continuously improve cut restoration management, achieve fewer disruptions within the Right-of-Way infrastructure and improve quality restoration services.*

# Table of Contents

<b>STREET CUTS MANUAL</b> .....	<b>1</b>
Streets By-Law 1481/77.....	1
Disclaimer.....	1
<b>DEFINITIONS</b> .....	<b>2</b>
<b>LICENSING</b> .....	<b>4</b>
License Requirements.....	4
All Street Cuts .....	4
Street Cut Restoration .....	4
Qualifications.....	4
<b>PERMITS AND APPROVALS</b> .....	<b>6</b>
Submission and Approval of Drawings .....	6
Street Cut Permit.....	7
<b>NOTIFYING BUSINESSES</b> .....	<b>10</b>
<b>TEMPORARY TRAFFIC CONTROL</b> .....	<b>11</b>
Street Lane Closures.....	11
Work on City Streets .....	11
Street Lane Closure Form.....	12
<b>CONSTRUCTION</b> .....	<b>13</b>
Worksite Protection.....	13
Site Clean Up .....	13
Protection of Trees.....	13
Street Excavation.....	14
Pavement Restoration Process .....	14
Backfill .....	14
Temporary Surface Restoration and Maintenance.....	15
Temporary Restoration – Capping Materials.....	16
Temporary Restoration – Winter Capping Materials .....	16

Restoration Inspection .....	17
Permanent Restoration .....	17
Warranty for Pavement Cuts Restored by Applicant .....	21
Pavement Restoration Guidelines for Asphalt and Asphalt over Concrete .....	22
Asphalt and Asphalt over Concrete Restoration Example.....	23
AT Path Restoration Example .....	24
Pavement Restoration Guidelines for Portland Cement Concrete .....	25
Portland Cement Concrete Restoration Example .....	26
Pavement Restoration Requirements for Series of Cuts.....	27
Boulevard Restoration Process .....	28
Backfill Compaction.....	28
Assessment .....	28
Restoration .....	29
Special Landscaping .....	30
Boulevard Restoration Area Example .....	31
<b>APPENDICES .....</b>	<b>32</b>
Appendix A: Standard Trench and Excavation Backfill .....	33
1) Under Boulevard or Soft Surface Median.....	33
Appendix B: Standard Trench and Excavation Backfill .....	34
2) Under Street Pavement .....	34
Appendix C: Standard Trench and Excavation Backfill .....	35
3) Under Miscellaneous Concrete Slabs, Paving Stones or Asphalt Hard Surface .....	35
Appendix D: Full-Depth Patches and Slab Replacement.....	36
Appendix E: Contraction Joint for Jointed Reinforced Concrete Pavement .....	37
Appendix F: Longitudinal Joint for Concrete Pavement.....	38

Appendix G: Bar Mat Reinforcement Layout for Full-Depth Concrete Repair.....	39
Appendix H: Joint Reinforcement for Full-Depth Concrete Repair.....	39
Appendix I: Catch Basin and Manhole Isolation Detail (New Pavements).....	41
Appendix J: Manhole Isolation Detail in Existing Pavements.....	42
Appendix K: Curb and Gutter Inlet Isolation Detail.....	43
Appendix L: Miscellaneous Sidewalk Isolations.....	44
Appendix M: Curb and Gutter.....	45
Appendix N: Concrete Sidewalk.....	46
Appendix O: Protection of Trees.....	47
LINKS.....	48
NOTES.....	49
CITY AREA BOUNDARIES.....	52
CONTACTS.....	53

# STREET CUTS MANUAL

The Street Cuts Manual has been prepared by the Public Works Department - Engineering Division to provide information and details on the process of restoring cuts within the City of Winnipeg Right-of-Way.

Compliance with Street Cuts Manual is required as stated under *Streets By-law No. 1481/77* section 4.12.02(1) and 4.12.02(2).

## Streets By-Law 1481/77

The amended *Streets By-law* can be found at the following City of Winnipeg website: <http://www.winnipeg.ca> under Services & programs, choose Bylaws & enforcement, and Bylaw listing. Reference to the *Streets By-law* throughout the *Street Cuts Manual* is always *By-law 1481/77*.

## Disclaimer

Information in this manual is intended to supplement the *Streets By-law 1481-77* including all amending By-laws and the City of Winnipeg *Standard Construction Specifications*.

## DEFINITIONS

**“Area Cut Inspector”** means an employee of the City of Winnipeg assigned to a specific city area to assess and inspect street cuts.

**“Boulevard”** means the grass and/or earth portion within the City Right-of-Way.

**“Capital Project”** means any major project on a Regional or Non-regional Street managed and/or supervised by the City of Winnipeg, in the form of reconstruction or rehabilitation of the street or section of the street utilizing Provincial and Capital Tax set aside by the council for the street upgrading per year.

**“City Block”** means from a street intersection to the next street intersection. Divided streets will count one (1) city block per direction of traffic.

**“City Street”** means any portion of the Right-of-Way under the same identifying name and street suffix authorized by the City of Winnipeg.

**“Construction Season”** means the period from May 1 through October 31 in any given calendar year. It only pertains to the time period and not the authorization of street cut repairs, which is weather dependent and accompanied by a notification from Public Works Department – Engineering Division.

**“Director”** means the Director of Public Works and any person to whom the Director has delegated authority given to the Director under Streets By-law.

**“Designated Employee”** means an employee of the City of Winnipeg to whom the Director has delegated authority to administer or enforce all or part of *Streets By-law* and Street Cuts Manual.



**“Emergency Repair”** is defined as using any forces or services to repair a damaged or failed infrastructure, within or below the street surface, that temporarily lost its function or service. The repair is necessary to reinstate the function or service of the infrastructure, and/or to prevent any nuisances or dangerous conditions to the public.

**“Pavement”** or the adjective “Paved” when used to describe a street, road, alley, sidewalk, or other area, refers to an area which has a surface constructed of Portland Cement concrete, asphaltic concrete, brick, tile or similar material.

**“Permit Amendment”** means any revisions to the original permit such as addition or reduction of repair fees, and changes to permit conditions.

**“Street”** means any place part of which has been dedicated as a roadway, lane, footpath, walkway, according to *The Real Property Act* or which the public is ordinarily entitled to use for passage, with or without fee or charge therefore, and includes all the space within the City Right-of-Way.

**“Street Cut”** means any cut, break, tear or excavation in a street surface or removal of any part of a street surface.

**“Street Cuts Manual”** means the *Street Cuts Manual* issued by the Director under clause 4.12.02(1) of the *Streets By-law* and, unless otherwise specified, refers to the most recent edition of the manual posted on the City of Winnipeg website.

**“Standard Construction Specifications”** means the *Standard Construction Specifications* for infrastructure work on City streets approved by the Public Works Department and, unless otherwise specified, refers to the most recent edition at: <https://winnipeg.ca/matmgt/spec/>.

# LICENSING

## License Requirements

### All Street Cuts

In order to obtain a permit for a street cut, a person must hold a subsisting and applicable license issued under:

- the *Streets By-law*, or
- the *Water By-law* or the *Sewer By-law*.

### Street Cut Restoration

Prior to restoring a pavement cut, the permit applicant or their agent must hold a subsisting and applicable *Restoration Contractor's License* issued under the *Streets By-law*.

## Qualifications

Prior to receiving a *Streets By-law License* and/or a *Restoration Contractor's License*, the applicant must:

- Satisfy the Director that they have the knowledge and the ability to meet the requirements of this *Street Cuts Manual*, and the *Streets By-law* and other applicable by-laws including the *Standard Construction Specifications* and the *Manual of Temporary Traffic Control*. For the applicant to demonstrate this, the Director may:
  - require that the applicant and all field foremen to complete a written examination and in-person interview;
  - rely on observations and reports of the applicant's past work; and

- issue a probationary license to the applicant, and subject the work of a probationary contractor to a specific inspection regime.
- Provide evidence of a policy of commercial general liability insurance consistent with *Section 6* of the *Streets By-law*.

For more information regarding licensing, contact:

***Supervisor of Right-of-Way Management***

Public Works Department  
Engineering Division  
Technology Services Branch  
106-155 Pacific Ave.,  
Winnipeg, MB, Canada R3E 3P1  
[OTarasov@winnipeg.ca](mailto:OTarasov@winnipeg.ca)

## PERMITS AND APPROVALS

### Submission and Approval of Drawings

- Prior to issuance of the permit, the applicant must submit drawings to Underground Structures and obtain approval before carrying out any Capital Project, installation or realignment of the utility infrastructure in, on, over or under a street.
- The drawing required must:
  - be in a form acceptable to the designated employee;
  - include any information reasonably required by the designated employee in order to approve the drawings; and
  - be submitted at least fourteen (14) days prior to the work.
- Where the work results in changes of alignment or grade or when requested by the designated employee to do so, the person carrying out the work must submit “record drawings” to the designated employee within sixty (60) days after the work has been completed.
- Inquiries regarding Capital Projects should be directed to the Supervisor of Right-of-Way Management (see *CONTACTS*).

#### ***Underground Structures***

Public Works Department  
Engineering Division  
Underground Structures Branch  
107-1155 Pacific Ave.,  
Winnipeg, MB, Canada R3E 3P1  
[ugsapproval@winnipeg.ca](mailto:ugsapproval@winnipeg.ca)  
(Monday to Friday from 08:00 to 16:00)

## Street Cut Permit

- No person shall cut, break, tear up or remove any street surface or make any excavation in, on, over or under a street for any purpose without first having obtained the appropriate permit(s) from the Director.
- The person responsible for making a street cut must apply for a Street Cut Permit at least forty-eight (48) hours prior to the commencement of work, with the exception of emergency repair work.
- For **emergency repair**, a permit is to be obtained within forty-eight (48) hours from the start of work or twenty-four (24) hours after work is completed, whichever is earliest.
- A Street Cut Permit is required for each address or location unless the work follows a continuous alignment as specified in a utility drawing.
- For planned utility work, providing the work follows a continuous alignment with multiple cuts along a city block(s), a single permit shall be issued per City Street, with a permit fee charged per City Block.

The applicant is required to submit a utility drawing indicating the location and/or alignment of the work to Public Works – Underground Structures for approval. Upon approval, a request for permit via email must be submitted to Public Works – Customer Services, including the following information:

- Name of the prime utility for the proposed work
- Description of the work area
- Number of city blocks

- List each City Street affected by work
  - Street Name (i.e. Nairn Ave): From the first street intersection on the first block (i.e. Grey St) - To the last street intersection on the last block (i.e. Keenleyside St) (*Note: Divided streets require one (1) permit per direction of traffic*)
  - Quantity per block (Mud, Pavement, Curb, etc.)
- Site Plan Summary (For utility drawings over one page)
- Utility Plan Drawing(s)
- A **late fee** will be charged if a Street Cut Permit has not been obtained prior to commencement of work. Additional charges from an Operations Constable may apply in contravention of the *Streets By-law*.
- As part of an application, the applicant must pay a Street Cut Permit fee and one or more street cut repair fees established by Council from time to time. Street cut repair fees shall be sufficient to restore the street to a condition satisfactory to the Director. Pavement Restoration Guidelines and Boulevard Restoration Guideline are provided in this manual.
- The permit applicant is responsible for restoring any pavement cuts related to a permit issued for a regional street address, as well as any pavement cuts made on a regional street, irrespective of the associated address stated on the permit.
- Any utility contractors performing work that is unrelated to water, sewer and/or gas infrastructure, whether on a single location or on a block-to-block basis, are required to self-restore all their street cuts which includes hard surface and boulevard. All hard surface cuts must be restored by a Licensed

Restoration Contractor, and boulevard cuts must be restored to the same condition or better as the surrounding boulevard, regardless of restoration method (*see Boulevard Restoration Process*).

- Pavement undermining related to the street cut and/or not achieving a proper full-depth cut will increase the repair limits.
- The applicant may contact the designated employee prior or subsequent to issuance of the permit to determine an estimated restoration area. (*See CITY AREA BOUNDARIES and CONTACTS*)
- The street pavement ratings are available by visiting the City of Winnipeg website at <http://www.winnipeg.ca/> and by selecting Departments > Public Works > Maps > [Street Conditions](#).
- Permit applicants have up to fourteen (14) calendar days to dispute any *permit amendments*. To dispute assessment, the applicant must provide clear reasoning, references to rules and photographs as to the reason of dispute via email, by using the dispute form attached on the permit amendment. The information provided will be reviewed and a decision will be communicated to the applicant. If the request for change is accepted, a revised assessment will be sent to the applicant. If the request for change is denied, the latest assessment will remain.

In cases where Public Works does not have sufficient photos and/or required information, the applicant will be required to provide the information prior to the end of the dispute time period as indicated on the assessment. (*Note: Permit applicants*

*are required to take site photos with timestamp before commencing work and after completing work. Otherwise, the dispute will be invalid.)*

- **Refunds** only apply to street cut repair fees, excluding Latent Sinkage fees if excavation on boulevard occurred. Permit fee is non-refundable.
- The restoration process for multiple cuts related to Major Utilities Capital Projects must be approved by the Supervisor of Right-of-Way Management (see *CONTACTS*) and will require the applicant to enter into an agreement to contract out the restoration along with hiring a private consultant for engineering services.

### **Customer Service Permit Clerks**

Public Works Department  
Customer Services Division  
107-1155 Pacific Ave.,  
Winnipeg, MB, Canada R3E 3P1  
[pwdcspemits@winnipeg.ca](mailto:pwdcspemits@winnipeg.ca)  
204-986-3184

## **NOTIFYING BUSINESSES**

Utility companies are to provide advance notice containing general construction timelines and information to businesses that will experience a parking and/or loading effect as a result of construction.

Notification is required if all the following parameters are met:

- Planned work
- Duration of work is five (5) business days or longer
- On street parking and/or loading is affected by construction



A standard format notice shall be delivered to affected businesses along the City block(s) five (5) business days prior to commencement of work and/or post a form of notice at the site depending on the challenges presented by the adjacent land use within the same timeframe.

The notice shall include the following information:

- Limits of work
- Description of work
- Timeline of construction
- Contact information of person in charge of work

## **TEMPORARY TRAFFIC CONTROL**

### **Street Lane Closures**

The Contractor is subject to the Construction Agency responsibilities outlined in *Section 2 of the Manual of Temporary Traffic Control*. This includes, but is not limited to, the requirement to obtain approval from the Traffic Management Branch to work on all City Streets.

If the restoration contractor is different than the permit applicant, the restoration contractor must contact the Traffic Management Branch to ensure that approval has been granted for the lane closure.

### **Work on City Streets**

When deemed necessary by the Director of Public Works, contractors doing work on City Streets are required to do all things necessary to expedite completion of the work. This includes all pavement restorations and is to be achieved through the use of:

- 24-hour activities
- Weekend work activities
- Steel plating of excavations during a.m. and/or p.m. peak rush hour periods

The permit applicant and/or restoration contractor are required to contact the Traffic Management Branch prior to commencing work to ensure the applicable guidelines are followed.

For additional information regarding work duration categories, see *Section 3.03 of the Manual of Temporary Traffic Control*.

## **Street Lane Closure Form**

Visit the City of Winnipeg website at <http://www.winnipeg.ca/> and select Departments > Public Works > Transportation > Traffic Management > [Request or manage a lane closure in the public right-of-way](#).

### ***Traffic Management***

Public Works Department  
Transportation Division  
Traffic Management Branch  
101-1155 Pacific Ave.,  
Winnipeg, MB, Canada R3E 3P1  
[PWDLaneClosures@winnipeg.ca](mailto:PWDLaneClosures@winnipeg.ca)  
(Monday to Friday from 08:30 to 16:30)

## CONSTRUCTION

### Worksite Protection

It is the permit applicant's responsibility for all work processes, safety and signing, until the cut has been permanently restored with the inspection and approval of the Area Cut Inspector.

Every excavation in a street shall proceed expeditiously and the permit applicant shall not allow a street cut excavation to remain open, unless the work is actively in progress.

All work within the Right-of-Way must be controlled in accordance with the *Manual of Temporary Traffic Control*.

Vehicular and pedestrian traffic is to be maintained with the structural capacity to maintain safe passage, at any time of the day.

### Site Clean Up

Upon completion of work or activity, all excess material shall be removed from the area of the construction site. The site shall be left in a safe, neat and clean condition to the satisfaction of the Director. The permit applicant or its agent must ensure that traffic flow and/or drainage shall be reinstated before leaving the site.

### Protection of Trees

The Contractor shall take precautionary steps as specified in *Appendix O: Protection of Trees* to prevent damage from construction activities to existing boulevard trees within the limits of the construction area. All damage to existing trees caused by the Contractor's activities shall be repaired to the requirements of the City Forester or the designate.

## Street Excavation

- All excavations shall be done in accordance with *Standard Construction Specifications CW 2030, CW 2160 and CW 3230*.
- All pavement cuts must achieve full-depth sawcut in accordance with *CW 3230* with the exception of emergency work. Full-depth sawcut on a composite pavement will be considered when a 200mm sawcut has been achieved on the concrete base.
- All **utility clearances** are the responsibility of the permit applicant or their agent.

## Pavement Restoration Process

### Backfill

- Backfill all cuts under road pavement and/or within 450mm of a road pavement edge, including approaches, with **Cement-Stabilized Fill (CSF)** to a **minimum depth of one (1) meter** from the underside of the finished pavement, if applicable. This should be done in accordance with *CW 2030* and *Table CW 21601.1*.
- No pavement material shall be placed until bleed water has been evaporated from the CSF surface or has been drained or removed from the surface. **CSF is not permitted** as a temporary driving surface.
- Any voids discovered in the excavation during the course of construction are to be filled with Flowable Cement-Stabilized Fill in accordance with *CW 2030* and *Table CW 2160.1*.
- For all sewer and water infrastructure related work, documentation of the backfill process shall be submitted to

[pwd-stabilizedfill@winnipeg.ca](mailto:pwd-stabilizedfill@winnipeg.ca). The email must include the following information:

- Permit number must be the email subject line;
- A copy of the CSF ticket; and
- Photos of the entire excavation prior to, and after placement of CSF.

## Temporary Surface Restoration and Maintenance

Temporary restoration of utility pavement cuts shall be done in accordance with *CW 3310*.

The permit applicant must ensure that the temporary restoration of all cuts associated with the permit are monitored and maintained at all times in a condition that is safe for which that portion of the street is reasonably expected to be used. This obligation continues until all cuts associated with the permit are permanently restored to the satisfaction of the Director.

If the Director is of the opinion that any temporary restoration has created a hazardous situation which can endanger the public and/or cause damage to a vehicle, the Director may:

- issue charges under the *Municipal By-law Enforcement Act* for minor offences and under the *Provincial Offences Act* for dangerous and serious offences; and
- notify the permit applicant of the unacceptable patches/trenches. The applicant is required to respond within three (3) hours upon notification, rectify the hazard within twenty-four (24) hours and provide photographic evidence of work completion. Failure to rectify the hazard within the given

timeframe may result in City Forces rectifying the hazard. Any costs incurred by the City for the maintenance of temporary restorations resulting from improper backfill, workmanship or compaction shall be passed on to the permit applicant.

## **Temporary Restoration – Capping Materials**

### All Pavement Cuts (Roads, Lanes, Approaches, Sidewalks & Medians):

- Type 7 concrete in accordance with *CW 3310* over Cement-Stabilized Fill; or
- Minimum 75mm of hot mix asphalt over Cement-Stabilized Fill

## **Temporary Restoration – Winter Capping Materials**

### Sidewalks & Approaches:

- From November 1 to April 30, when hot mix asphalt is not in production, Cement-Stabilized Fill (CSF) will be considered as an acceptable temporary capping material. The CSF shall be in accordance with *CW 2160*. The utility shall be independent and isolated from the surrounding temporary capping material; or
- An approved cold mix asphalt with a minimum thickness of 75mm.

### Roads, Lanes & Medians:

- From November 1 to April 30, when hot mix asphalt is not in production, Type 7 concrete in accordance with *CW 3310* is the only acceptable temporary capping material.

## Restoration Inspection

Inspection for the work done in preparation for the permanent restoration must be arranged via email with the Area Cut Inspector (see *CONTACTS*), at least twenty-four (24) hours prior to placement of any pavement material. If the applicant has failed to arrange an inspection or did not receive an approval from the Cut Inspector, the applicant must either demonstrate that the restoration meets the requirements (*compliance with this manual and the Standard Construction Specifications*), or remove the restored surface and re-construct it at no cost to the City of Winnipeg within fourteen (14) days of request. *Note: The applicant or their agent must provide the Street Cut Permit Number in the email when requesting for inspection.*

Contractors are required to adhere to inspector's requests for scheduling material testing, construction process inspection, and submission of any relevant documentation.

Inspections conducted by the Area Cut Inspectors will be **available until October 31<sup>st</sup>** of the current year.

## Permanent Restoration

- All restorations shall be done by a restoration contractor licensed under the *Streets By-law No. 1481/77* or by City forces, in accordance with this manual and the City of Winnipeg *Standard Construction Specifications*.
- Restoration standards and specifications outlined in this manual shall supersede the City of Winnipeg *Standard Construction Specifications* when permanently restoring pavement cuts. (*See APPENDICES*)

- During Construction Season, all pavement cuts made on **Regional Streets** or permits associated with a regional street address shall be restored by the applicant or their agent **no later than seven (7) days** after completion of any utility repair or installation activity, weather permitting. While pavement cuts made outside the Construction Season shall be restored by June 30 of the following Construction Season. Applicants who do not hold a restoration license must provide their appointed Licensed Restoration Contractor to the Right-of-Way Management Supervisor (*see CONTACTS*).
- All restorations on Regional Streets are to be restored using Early Opening 24-hour concrete (*Type 3 concrete in accordance with CW 3310*).
- All pavement cuts made on **Non-Regional Streets** from May 1 to September 30 in any given calendar year, shall be restored **within sixty (60) days**, weather permitting. Pavement cuts made outside of this period shall be restored by June 30 of the following construction season.
- Where a project or work requires a series of road cuts, the restoration shall be done in accordance with the *Pavement Restoration Requirements for Series of Cuts*.
- Permit applicants can elect to self-restore all pavement cuts on Non-Regional Streets by requesting approval from the Right-of-Way Management Supervisor. The applicant must hold a subsisting restoration license or hire a Licensed Restoration Contractor to permanently restore pavement cuts.
- If the perimeter of a road pavement cut is within one (1) meter of a joint or the pavement edge, the restoration area will be



extended to the joint or pavement edge, irrespective of street condition. Additional repair fees will be applied to the permit for this extended restoration area, as well as any necessary curb, splash strip, monolithic curb and sidewalk, or median replacements resulting from the extension.

- All utility cut restorations with concrete pavement thickness of 150mm or greater are to install bar mat reinforcements in accordance with *CW 3310* and *CD-07*. (See *Appendix G: Bar Mat Reinforcement Layout for Full-Depth Concrete Repair*)
- Temporary restored pavement cuts not parallel or perpendicular to the road alignment shall be corrected during permanent restoration. This adjustment may increase the size of the restoration area.
- Type 1A shall be the only acceptable asphalt type to be used for any pavement cut restoration.
- Sidewalk restoration shall be done in accordance with *CW 3325*, *CD-12* and *CD-14*. (See *Appendix L: Miscellaneous Sidewalk Isolations* and *Appendix N: Concrete Sidewalk*)
- All restorations around manholes and catch basins shall be separated by bond breaker and shall be done in accordance with *CD-09*, *CD-10* and *CD-11* (see *Appendix I: Catch Basin and Manhole Isolation Detail (New Pavements)*, *Appendix J: Manhole Isolation Detail in Existing Pavements* and *Appendix K: Curb and Gutter Inlet Isolation Detail*). A site meeting with BellMTS or Manitoba Hydro shall be required prior to any restorations are around their respective manholes.
- Products and suppliers to be used for pavement restoration must be approved by the City and can be found by visiting

[www.winnipeg.ca](http://www.winnipeg.ca) and selecting Departments > Corporate Finance > Materials Management > Standard Construction Specifications > Approved Product Suppliers or Approved Concrete Suppliers, or by using the following links:

- [Approved Product Suppliers](#)
- [Approved Concrete Suppliers](#)
- If Cut Details or Standard Details are unsuitable as references for restoration due to the street's construction with e-specifications, contact the Area Cut Inspector for assistance.
- For hot weather conditions, concrete placement shall be done in accordance with *CW 3310 Clause 6.12*.
- For cold weather conditions, when air temperature is forecasted by Environment Canada to drop below 5°C, a minimum R-value of 4 for insulated tarps must be utilized to protect concrete during pavement cut restorations. Contractors must furnish evidence of the tarp's insulation rating; otherwise, tarps will be presumed to have an insulation rating of R-value of 0.5.

Concrete placement is prohibited if the air temperature is expected to fall below -8°C within 24 hours of concrete placement, or if the average daily temperature is to drop below -10°C for three consecutive days as per Environment Canada's forecast.

- For acceptance of permanent restoration, the applicant or its agent must provide photo evidence of the restored pavement surface, that is free from defects or deficiencies. Work site

clean-up is also a part of restoration acceptance (*see Site Clean Up*).

### **Warranty for Pavement Cuts Restored by Applicant**

The warranty period will not commence until all pavement cut repairs associated with the permit have been completed.

The permit applicant is responsible for the repairs undertaken by the restoration contractor or their agents for a warranty period of one (1) year following the date of acceptance of permanent restoration.

The Director shall notify the permit applicant of observed defects or deficiencies, within the warranty period.

The permit applicant shall correct, to the satisfaction of the Director, all defects, deficiencies and damage identified by the designated employee in the manner and within four (4) weeks upon being notified.

If all outstanding defects or deficiencies have not been corrected during the given time period for corrections, or due to unfavorable weather conditions, then the warranty period may receive an extension for up to one (1) more year, or the City may repair any defects or deficiencies, whichever satisfies the Director. Any additional cost incurred by the City for the repair, or any emergency work as a result of improper backfill, compaction or poor workmanship, shall be passed on to the permit applicant.

# Pavement Restoration Guidelines for Asphalt and Asphalt over Concrete

Rated Pavement Condition of Segment	Regional Streets	Non-Regional Streets
	Action Required	Action Required
<b>New</b>	Grind and repave full lane width, and length of excavation or project (see Note A-3 and Pavement Restoration Requirements for Series of Cuts)	Grind and repave full lane width, and length of excavation or project (see Note A-3 and Pavement Restoration Requirements for Series of Cuts)
<b>Good</b>		
<b>Fair</b>		Decision after inspection by Public Works Department (see Notes A-2 and A-3)
<b>Poor</b>	Decision after inspection by Public Works Department (see Notes A-2 and A-3)	Isolated repairs accepted

**NOTES:**

**A-1** This table is only a guide. The actual extents of all pavement restorations are subject to pre-construction inspection and final approval by the Public Works Department.

**A-2** Factors used by the Public Works Department to determine the extent of pavement restoration (Generally, in order of importance but not limited to):

- Condition of surrounding pavement prior to start of project
- Age of pavement
- Classification of street (e.g. regional vs local)
- Planned work in the right-of-way (future street projects)
- Length of project
- Number of required cuts in the project (see *Pavement Restoration Requirements for Series of Cuts*)

**A-3** For asphalt surfaces requiring grind and repave, the area must be milled to a depth of 40mm. If the depth of asphalt removal exceeds the specified extent and reveals a compromised subsurface, the Area Cut Inspector may deem it necessary to perform a full-depth repair in the affected area.

# Asphalt and Asphalt over Concrete Restoration Example

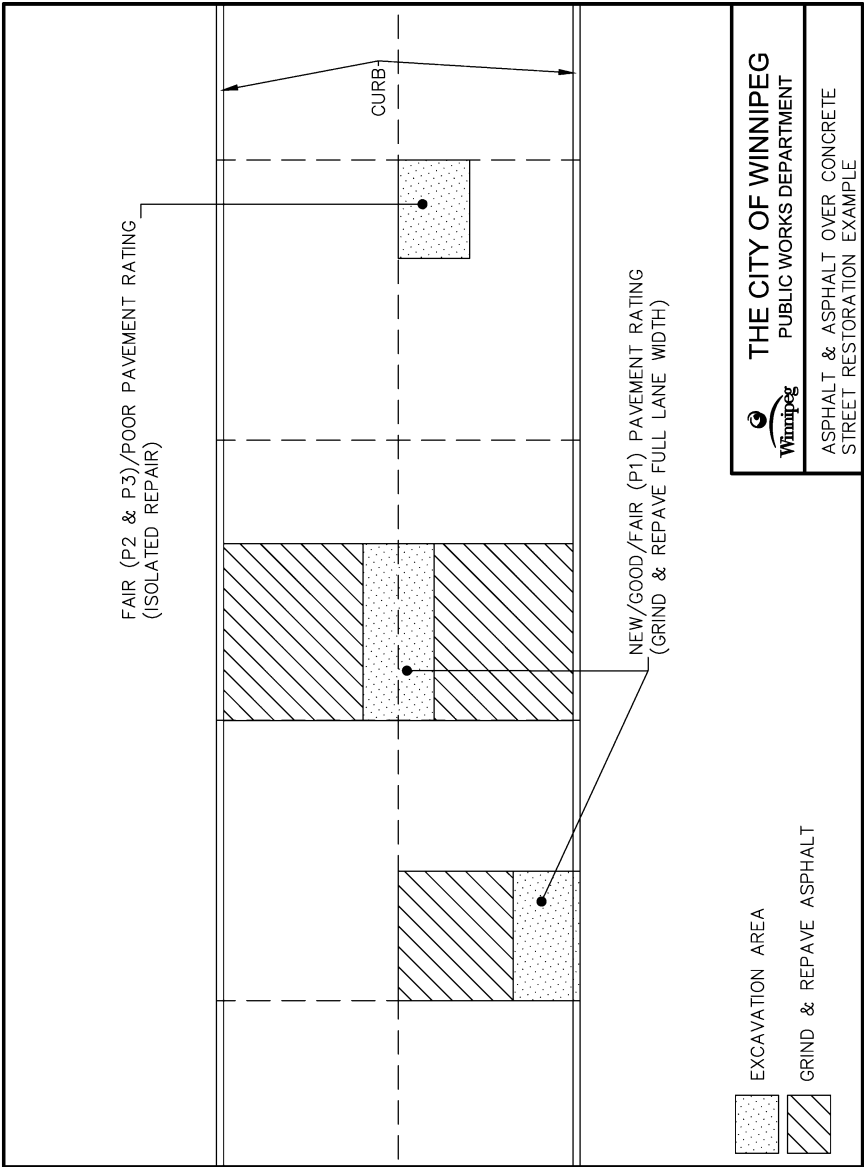

# AT Path Restoration Example

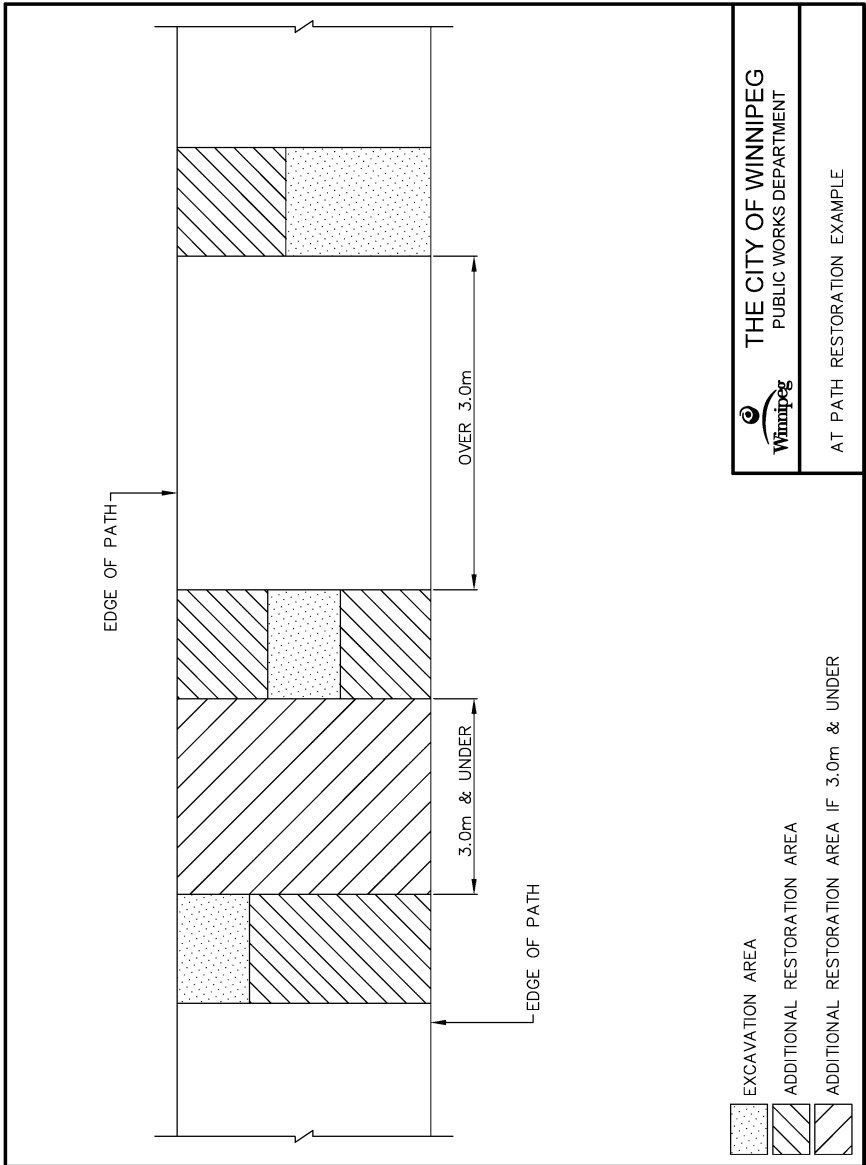

# Pavement Restoration Guidelines for Portland Cement Concrete

Rated Pavement Condition of Segment	Regional Streets	Non-Regional Streets
	Action Required	Action Required
New	Full panel repair	Full panel repair
Good		
Fair	Decision after inspection by Public Works Department <i>(see Note B-2)</i>	Decision after inspection by Public Works Department <i>(see Note B-2)</i>
Poor		Isolated repairs accepted

**NOTES:**

**B-1** This table is only a guide. The actual extents of all pavement restorations are subject to pre-construction inspection and final approval by the Public Works Department.

**B-2** Factors used by the Public Works Department to determine the extent of pavement restoration (Generally, in order of importance but not limited to):

- Condition of surrounding pavement prior to start of project
- Age of pavement
- Classification of street (e.g. regional vs local)
- Planned work in the right-of-way (future street projects)
- Length of project
- Number of required cuts in the project

# Portland Cement Concrete Restoration Example

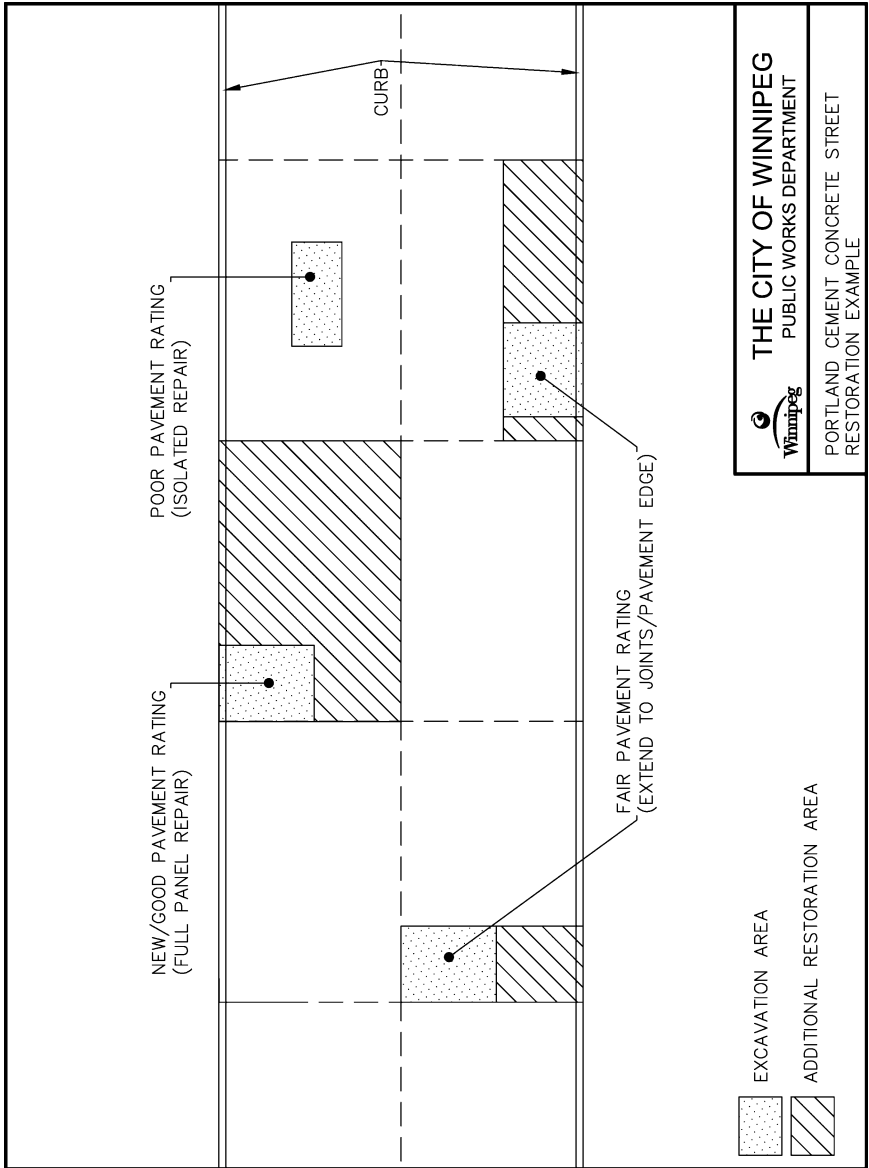



## Pavement Restoration Requirements for Series of Cuts

Where a series of road cuts occur along asphalt or composite pavements at distances less than those identified in Table 1, the restoration should include milling a minimum depth of 40mm for the full width of the lane and replacing the asphalt surface between the cuts to restore the quality of the driving surface.

Table 1: Minimum Distance Between Cuts

Pavement Condition	Posted Roadway Speed Limit	
	≤ 60 km/hr	> 60 km/hr
New	12m	20m
Good	10m	12m
Fair	8m	10m
Poor	Decision after inspection by Public Works Department	Decision after inspection by Public Works Department

### NOTE:

- The actual extents of all pavement restorations are subject to pre-construction inspection and final approval by the Public Works Department.

## Boulevard Restoration Process

### Backfill Compaction

Applicants can choose between mechanical compaction or jetting, flooding and tamping for backfill compaction.

#### Mechanical Compaction of Backfill

- All boulevard cuts as Class 2 Backfill: Use Type 1 material, with vibratory compactor in maximum 300mm layers to at least 95% of Standard Proctor Density, in accordance with *CW 2030*.
- All boulevard cuts as Class 4 Backfill: Use suitable excavated material compacted by mechanical means in maximum 300mm layers to a density equivalent to that of surrounding unexcavated material, in accordance with *CW 2030*.

#### Jetting, Flooding and Tamping of Backfill

- All boulevard cuts made between and including May 15<sup>th</sup> and October 15<sup>th</sup> must be flood tamped immediately following backfilling operations in accordance with *CW 2030*.
- All boulevard cuts made between and including October 16<sup>th</sup> (of the previous year) and May 14<sup>th</sup> (of the current year) must be **flood tamped by June 15<sup>th</sup>** of the current year in accordance with *CW 2030*.

### Assessment

- All boulevard restoration areas shall be rectangular in shape and extended to the back of curb if boulevard width is five (5) meters or less. (*See Boulevard Restoration Area Example*)

- For ditch and boulevard wider than five (5) meters, the restoration area shall be at the discretion of the designated employee.
- Collateral damages shall be included for the restoration area which encompasses access to the cut area, stored debris and backfill material piles, ruts, concrete work, and any other action that may cause damage to the cut location.
- Permit amendment may be issued at any time prior to or during the restoration process.
- Fees for latent sinkage, assessed based on the area, are applied to the permit for each cut made in boulevard and/or other grassed areas. The funds allocated to latent sinkage are utilized to regrade any sinkage that may occur in the future as a result of the cut, following final restoration.

In cases where boulevard cuts have been restored by the permit applicant and the excavation area(s) cannot be determined, latent sinkage charges will be equivalent to 25% of the total mud quantity.

## **Restoration**

- Restoration timeframes for boulevard cuts will be at the discretion of the Senior Boulevard Cut Inspector. Factors involved are the established contract(s), weather condition, time of the year, site accessibility and pending adjacent pavement cut repair.
- Boulevard cut restorations shall take place from May 15 to September 15. Any restoration beyond these dates must be

approved by the Senior Boulevard Cut Inspector (see *CONTACTS*).

- All permit applicants performing work unrelated to water, sewer, and/or gas infrastructure, whether at a single location or on a block-to-block basis, are required to self-restore boulevard cuts.
- All self-restored boulevard cut restorations must be maintained until they have met all criteria for the termination of the maintenance period specified in CW3510 / CW3520.

Once termination criteria have been met, the boulevard cuts must undergo inspection by the Senior Boulevard Cut Inspector.

## **Special Landscaping**

- Care must be taken to minimize damage to special landscaping when performing work under a Street Cut Permit.
- When an excavation and/or collateral damages disrupt any special landscaping materials, other than grassed areas, the Right-of-Way Management team will reach out to the affected property owner to discuss restoration options.
- In cases where a permit is identified as self-restore for boulevard cuts, the permit applicant is responsible to coordinate the restoration of any special landscaping with the property owner.

# Boulevard Restoration Area Example

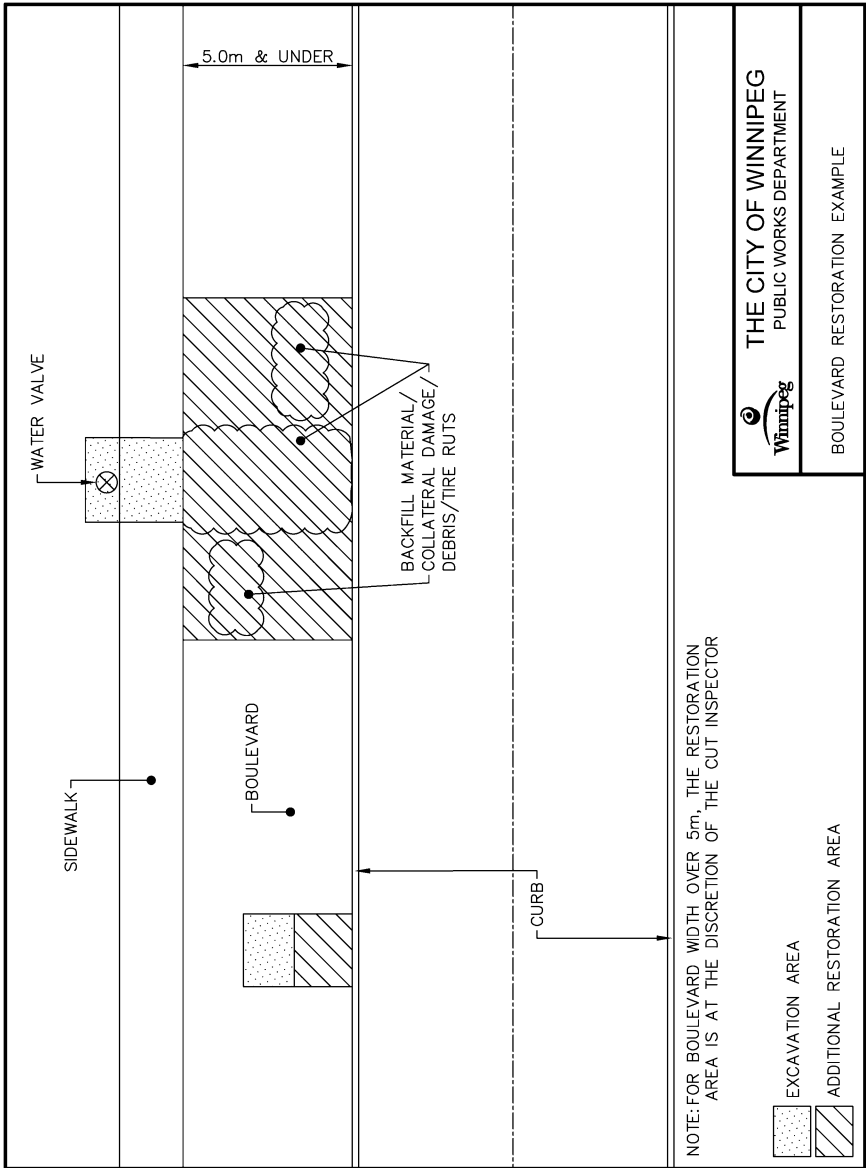

## APPENDICES

Cut Details (CD) printed in the appendices section of this manual shall supersede the City of Winnipeg Standard Details (SD) and must be adhered to when restoring street cuts.

Where a Standard Detail drawing number is referred to within a Cut Detail drawing, the contractor shall adhere to the City of Winnipeg Standard Details found on the following link:

<https://legacy.winnipeg.ca/matmgt/spec/>

If clarification is needed or any questions regarding the Cut Detail drawings, contact one of the Area Cut Inspectors (see *CONTACTS*).

# Appendix A: Standard Trench and Excavation Backfill

## 1) Under Boulevard or Soft Surface Median

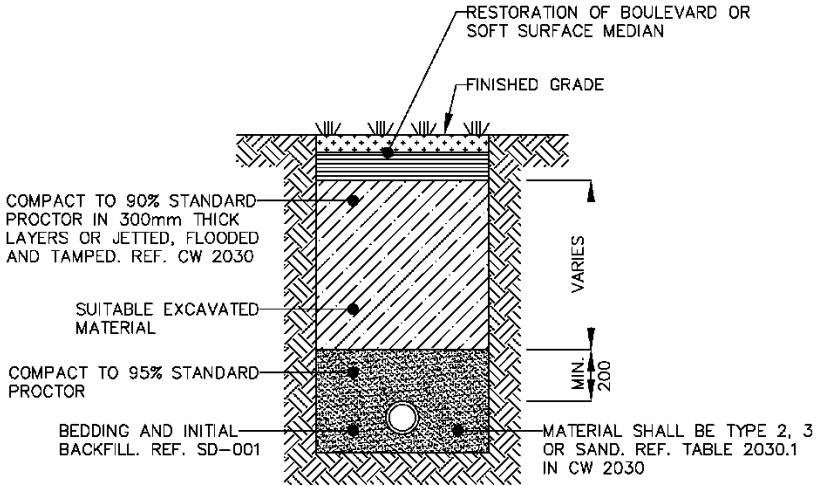

NOTE: 1. RESTORATION TO MATCH EXISTING GRADES



**THE CITY OF WINNIPEG**  
PUBLIC WORKS DEPARTMENT

DIMENSIONS ARE IN MILLIMETRES

STANDARD TRENCH AND EXCAVATION  
BACKFILL UNDER BOULEVARD OR  
SOFT SURFACE MEDIAN

Reference Spec. No.  
CW 2030

Scale :  
N.T.S.

Approved:  
R.O.W. MANAGEMENT TEAM

Drawing No.  
CD-01

# Appendix B: Standard Trench and Excavation Backfill

## 2) Under Street Pavement

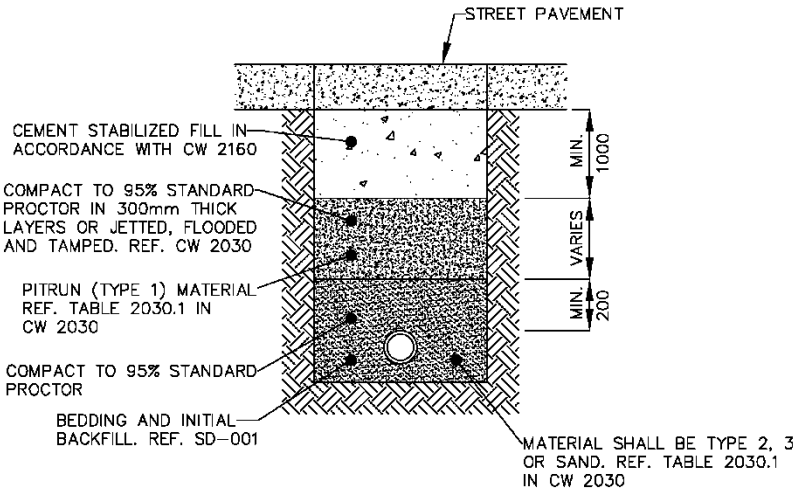

NOTE: 1. RESTORE STREET PAVEMENT IN ACCORDANCE WITH CW 3230



**THE CITY OF WINNIPEG**  
PUBLIC WORKS DEPARTMENT

DIMENSIONS ARE IN MILLIMETRES

STANDARD TRENCH AND EXCAVATION  
BACKFILL UNDER STREET PAVEMENT

Reference Spec. No.  
CW 2030, CW 3230

Scale :  
N.T.S.

Approved:  
R.O.W. MANAGEMENT TEAM

Drawing No.  
CD-02



## Appendix C: Standard Trench and Excavation Backfill

### 3) Under Miscellaneous Concrete Slabs, Paving Stones or Asphalt Hard Surface

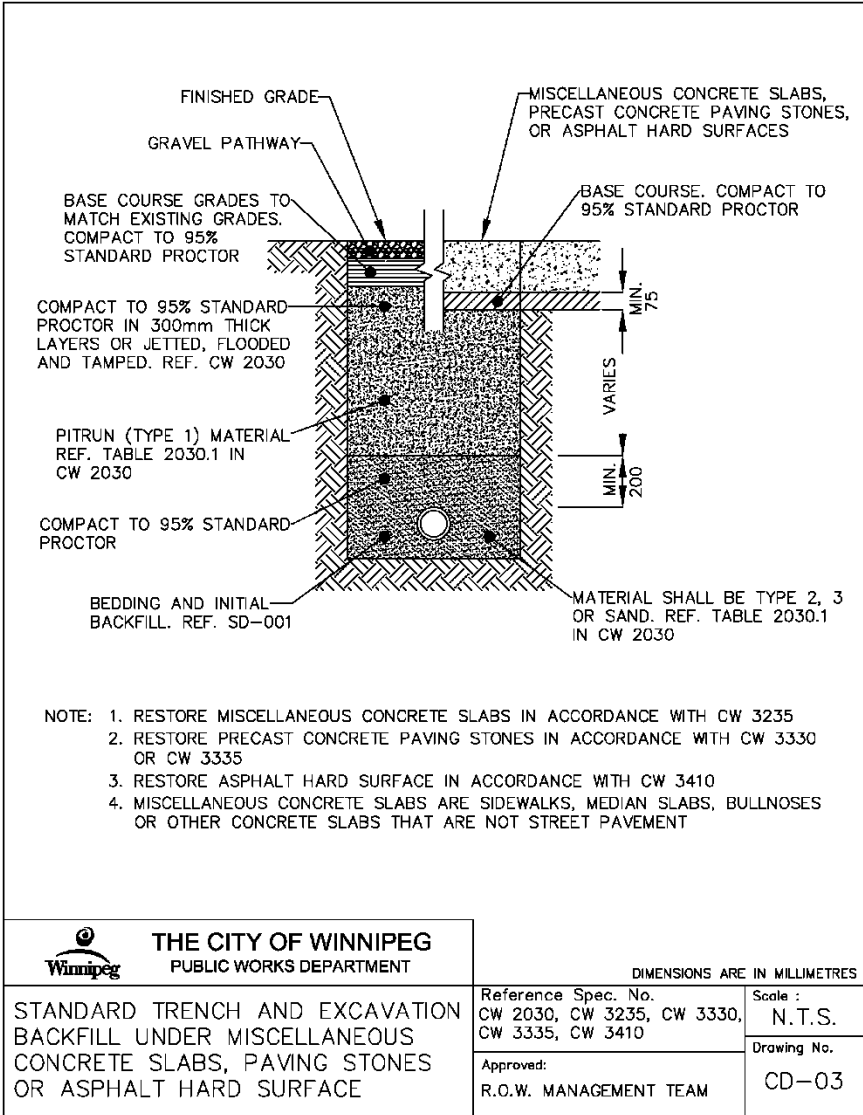

# Appendix D: Full-Depth Patches and Slab Replacement

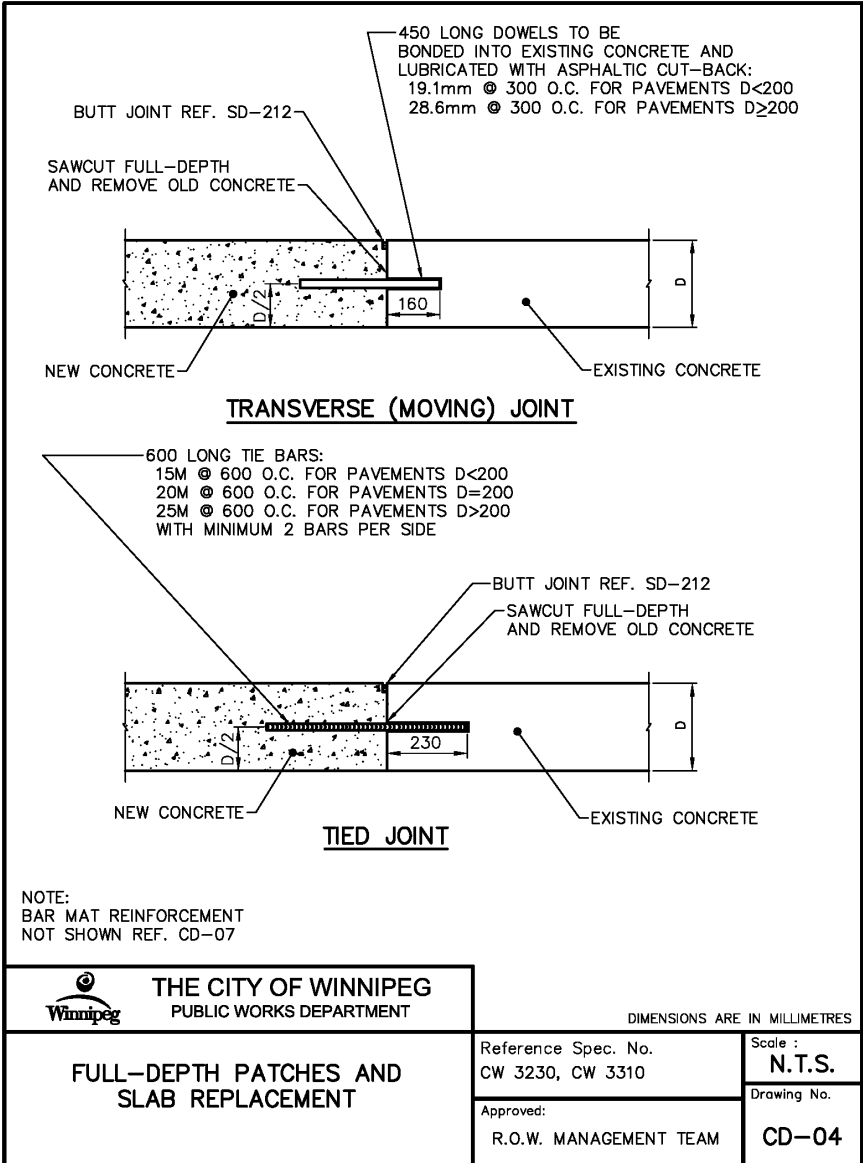

# Appendix E: Contraction Joint for Jointed Reinforced Concrete Pavement

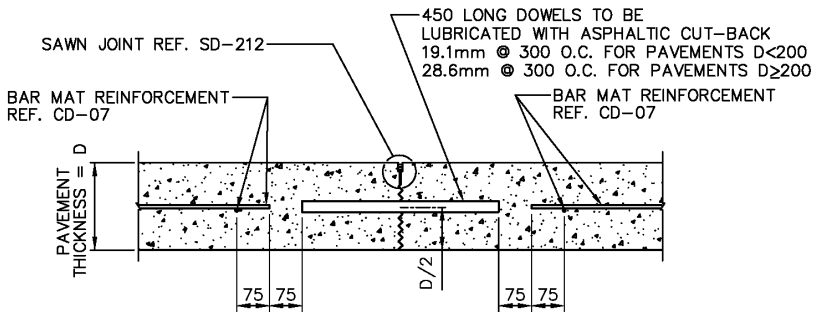

**SAWN CONTRACTION JOINT**

NOTE:  
DOWEL ASSEMBLIES NOT SHOWN



**THE CITY OF WINNIPEG**  
PUBLIC WORKS DEPARTMENT

DIMENSIONS ARE IN MILLIMETRES

**CONTRACTION JOINT FOR  
JOINTED REINFORCED  
CONCRETE PAVEMENT**

Reference Spec. No.  
CW 3230, CW 3310

Scale :  
**N.T.S.**

Approved:  
R.O.W. MANAGEMENT TEAM

Drawing No.  
**CD-05**

# Appendix F: Longitudinal Joint for Concrete Pavement

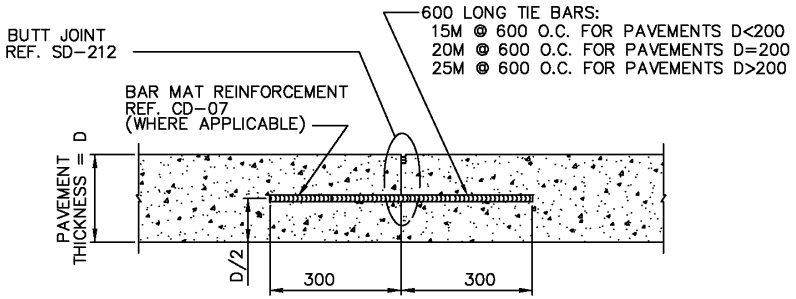

FORMED LONGITUDINAL JOINT

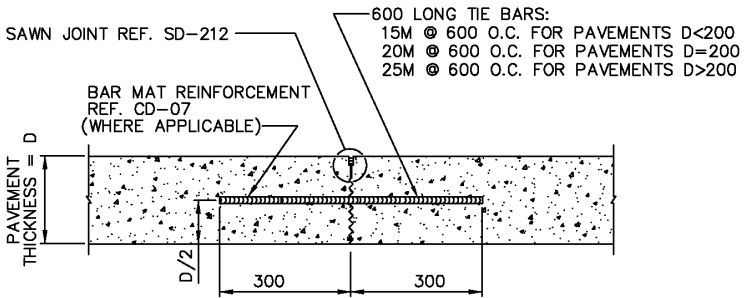

SAWN LONGITUDINAL JOINT



**THE CITY OF WINNIPEG**  
PUBLIC WORKS DEPARTMENT

DIMENSIONS ARE IN MILLIMETRES

LONGITUDINAL JOINT FOR  
CONCRETE PAVEMENT

Reference Spec. No.  
CW 3230, CW 3310

Scale :  
N.T.S.

Approved:  
R.O.W. MANAGEMENT TEAM

Drawing No.  
CD-06

# Appendix G: Bar Mat Reinforcement Layout for Full-Depth Concrete Repair

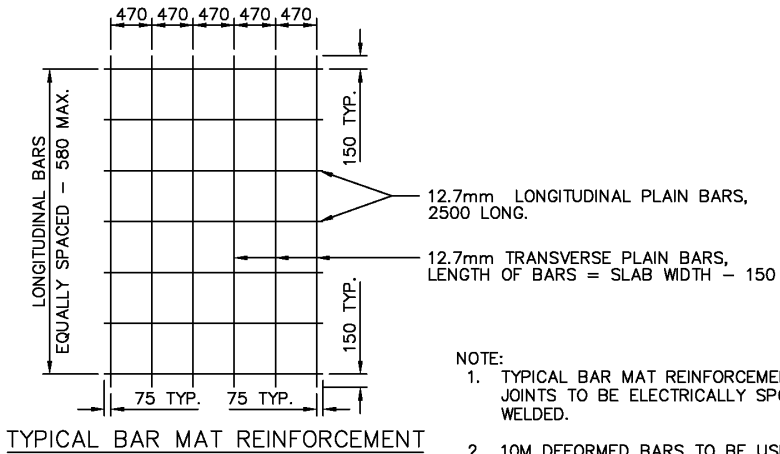

**NOTE:**

1. TYPICAL BAR MAT REINFORCEMENT JOINTS TO BE ELECTRICALLY SPOT WELDED.
2. 10M DEFORMED BARS TO BE USED ONLY TO COMPLETE THE REINFORCEMENT GRID OR AN AREA WHERE A TYPICAL WELDED BAR MAT IS NOT FEASIBLE FOR PLACEMENT.
3. STEEL WIRE TO BE USED WHEN TYING 10M DEFORMED BARS.
4. ALL DIMENSIONS ARE TO CENTRES OF BARS.

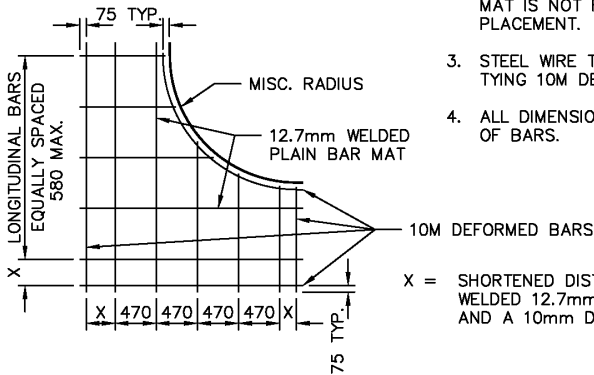

X = SHORTENED DISTANCE BETWEEN A WELDED 12.7mm PLAIN BAR MAT AND A 10mm DEFORMED BAR



**THE CITY OF WINNIPEG**  
PUBLIC WORKS DEPARTMENT

DIMENSIONS ARE IN MILLIMETRES

BAR MAT REINFORCEMENT LAYOUT  
FOR FULL-DEPTH CONCRETE REPAIR

Reference Spec. No.  
CW 3230, CW 3310

Scale :  
N. T. S.

Approved:  
R.O.W. MANAGEMENT TEAM

Drawing No.  
CD-07

# Appendix H: Joint Reinforcement for Full-Depth Concrete Repair

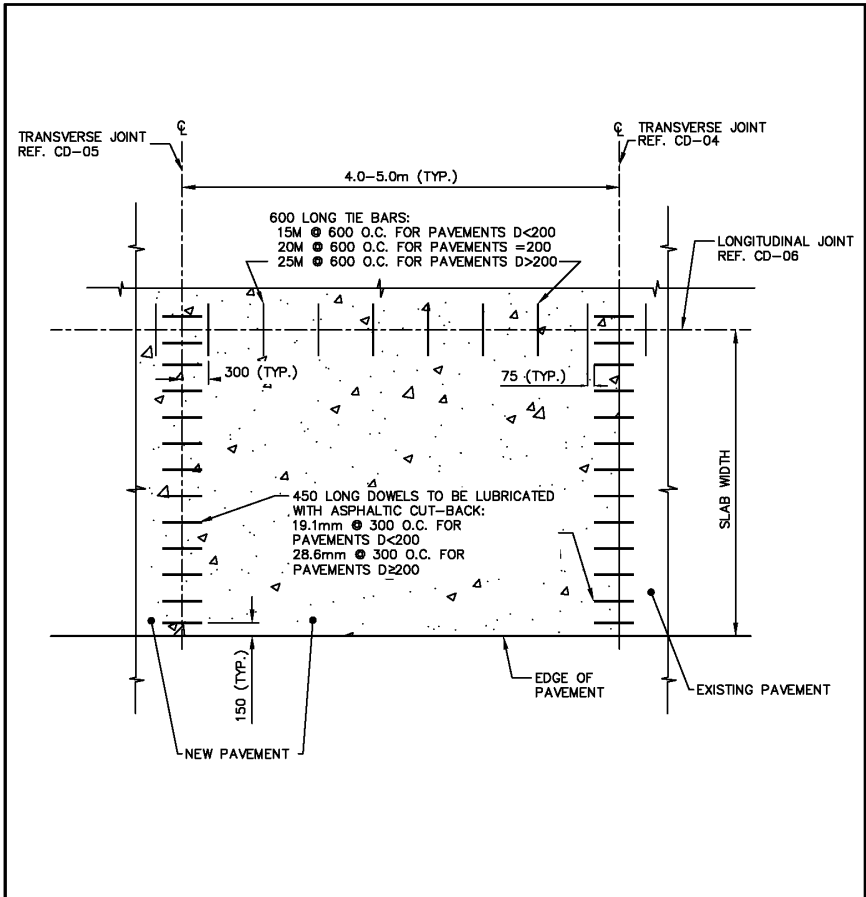

- NOTES:
1. BAR MAT REINFORCEMENT NOT SHOWN. ADJOINING WELDED BAR MATS TO OVERLAP MIN. 150
  2. SAWN OR BUTT JOINTS REF. SD-212



**THE CITY OF WINNIPEG**  
PUBLIC WORKS DEPARTMENT

DIMENSIONS ARE IN MILLIMETRES

**JOINT REINFORCEMENT FOR  
FULL-DEPTH CONCRETE  
REPAIR**

Reference Spec. No.  
CW 3230, CW 3310

Scale :  
**N.T.S.**

Approved:  
R.O.W. MANAGEMENT TEAM

Drawing No.  
**CD-08**

# Appendix I: Catch Basin and Manhole Isolation Detail (New Pavements)

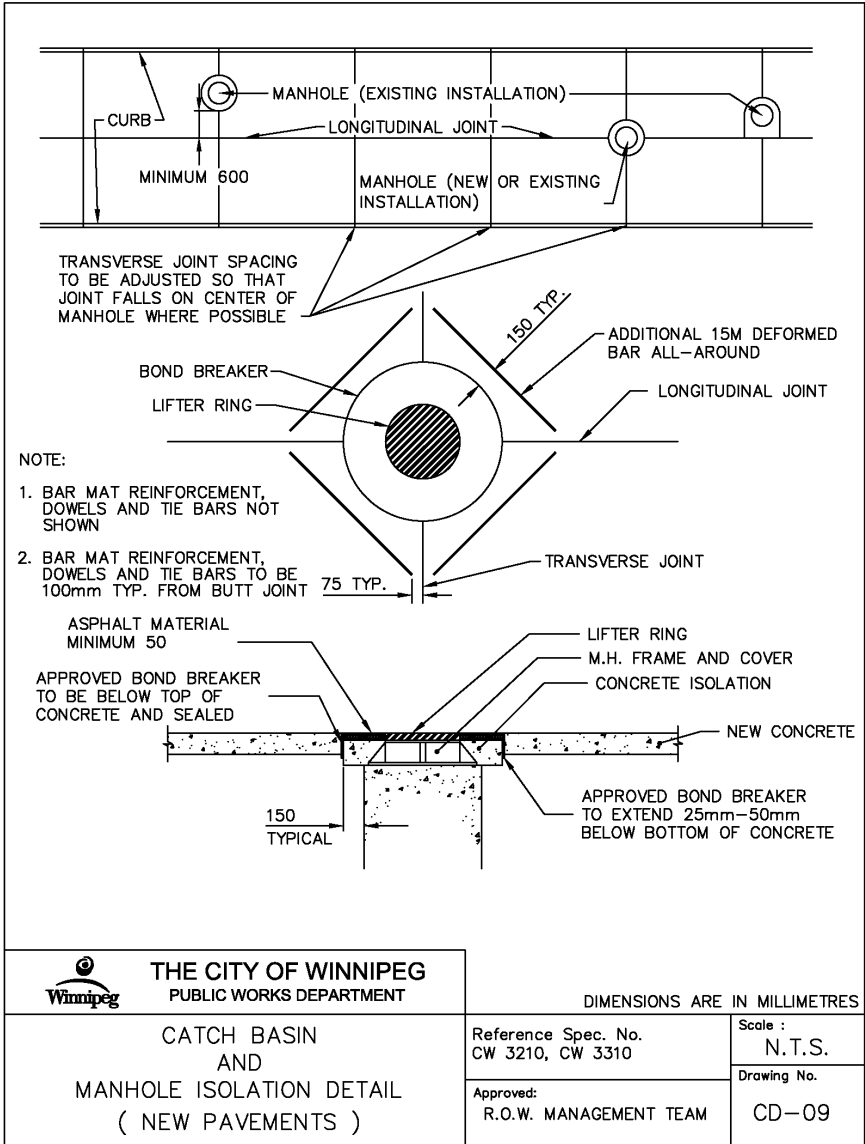

**THE CITY OF WINNIPEG**  
PUBLIC WORKS DEPARTMENT

DIMENSIONS ARE IN MILLIMETRES

CATCH BASIN  
AND  
MANHOLE ISOLATION DETAIL  
( NEW PAVEMENTS )

Reference Spec. No.  
CW 3210, CW 3310

Scale :  
N.T.S.

Approved:  
R.O.W. MANAGEMENT TEAM

Drawing No.  
CD-09

# Appendix J: Manhole Isolation Detail in Existing Pavements

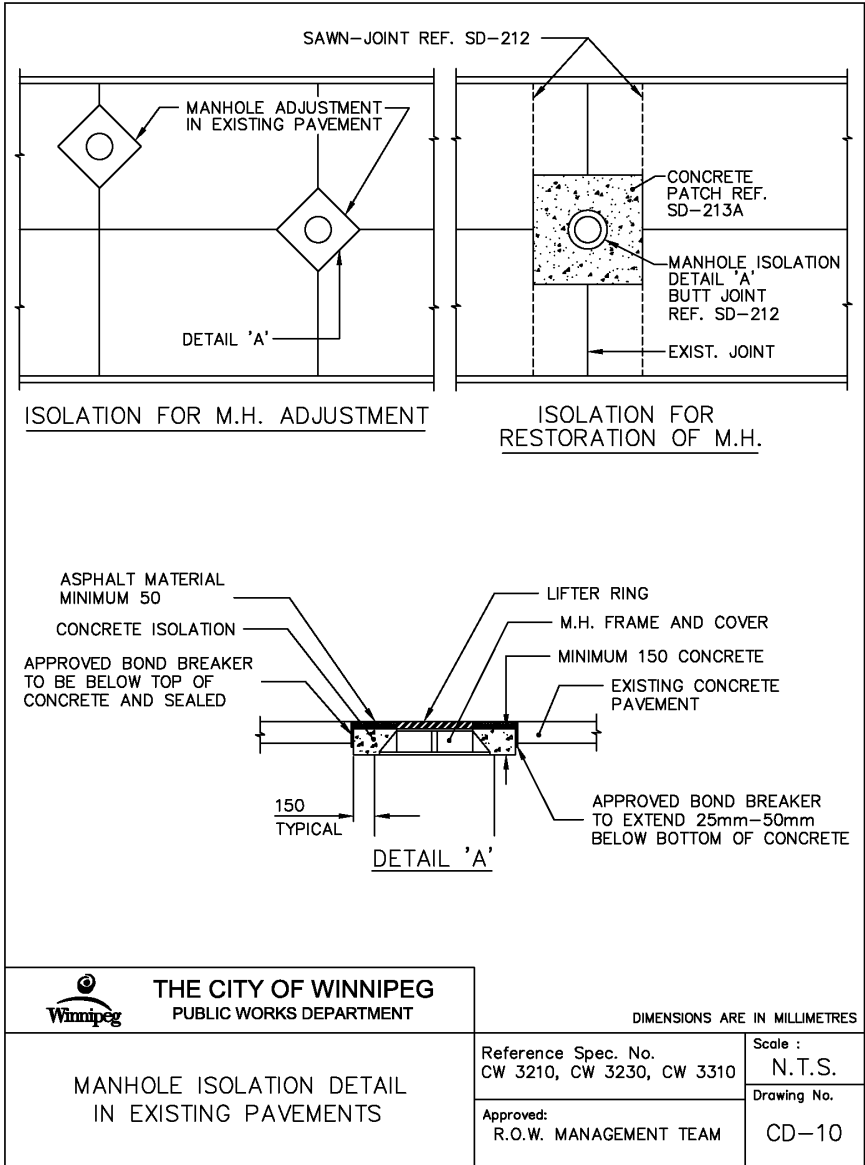



# Appendix K: Curb and Gutter Inlet Isolation Detail

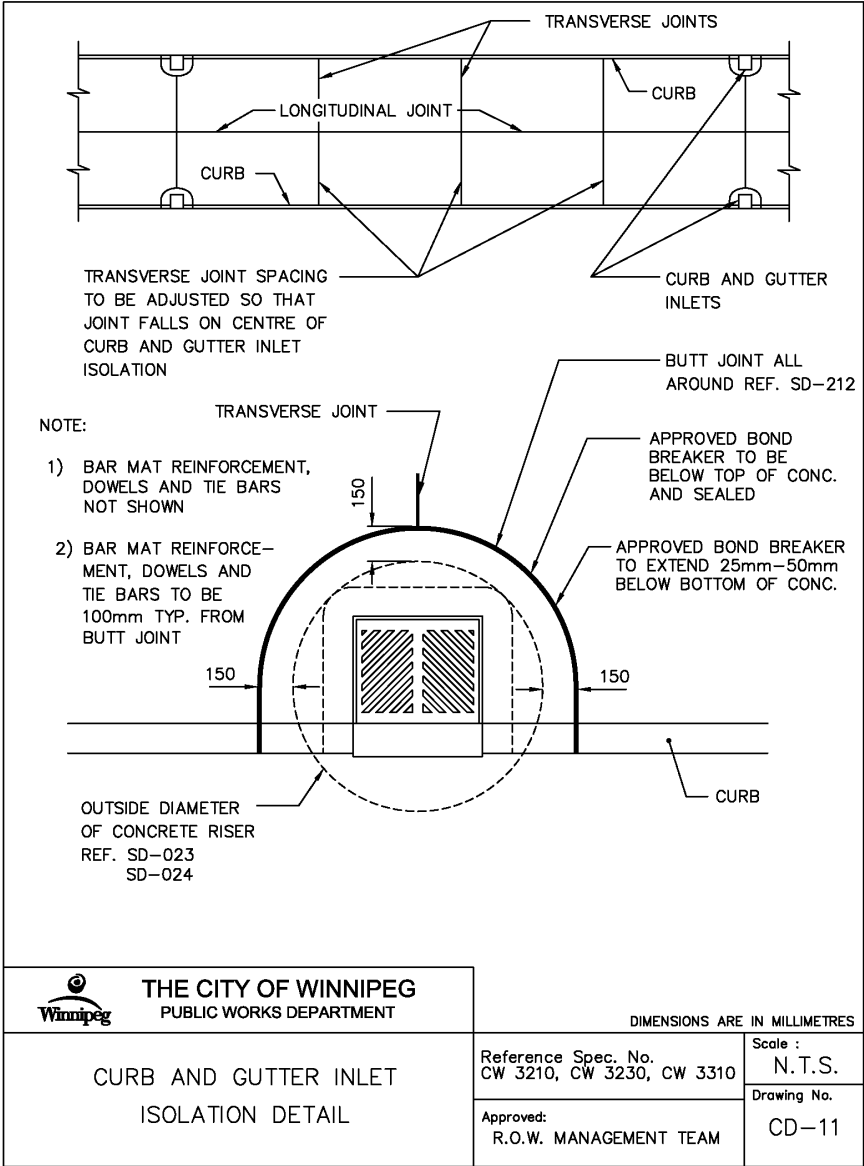

**THE CITY OF WINNIPEG**  
PUBLIC WORKS DEPARTMENT

DIMENSIONS ARE IN MILLIMETRES

CURB AND GUTTER INLET  
ISOLATION DETAIL

Reference Spec. No.  
CW 3210, CW 3230, CW 3310

Scale :  
N.T.S.

Approved:  
R.O.W. MANAGEMENT TEAM

Drawing No.  
CD-11

# Appendix L: Miscellaneous Sidewalk Isolations

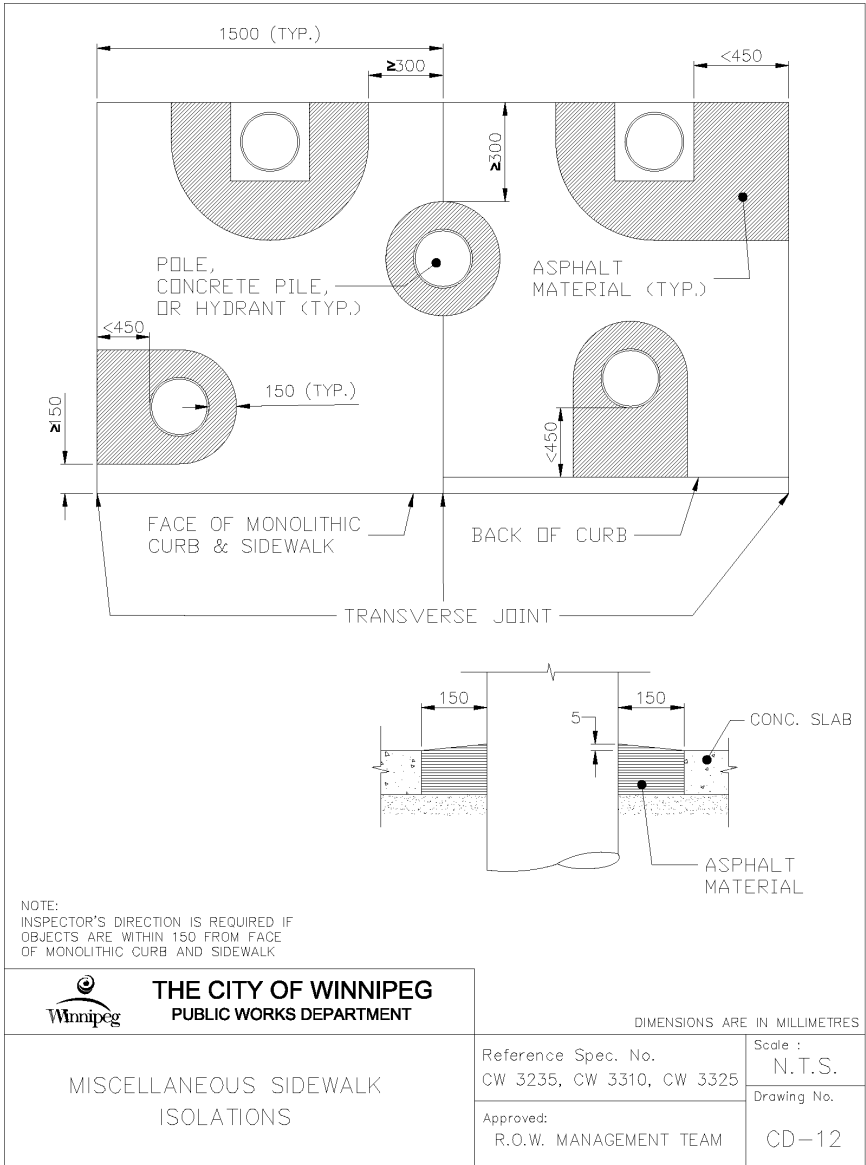

## Appendix M: Curb and Gutter

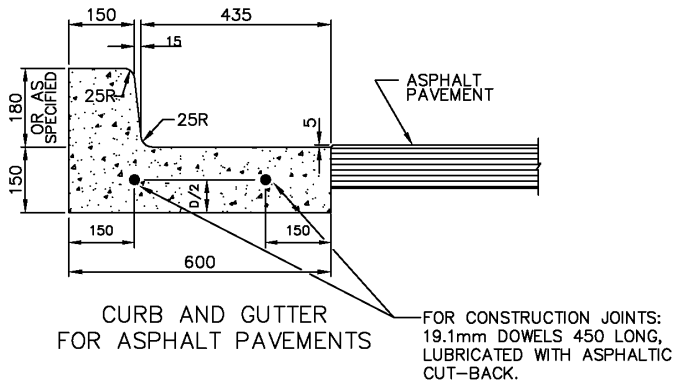
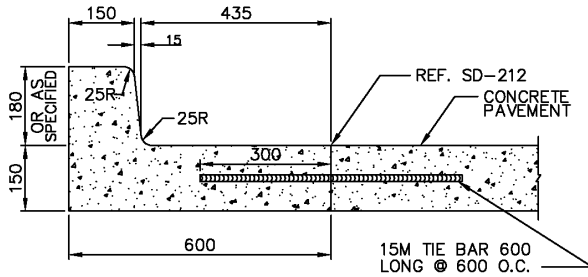

NOTE: 1. REDUCE CURB HEIGHT TO 40.  
APPLICABLE FOR PRIVATE  
APPROACHES ON LOCAL RESIDENTIAL  
STREETS. REF SD-202B

2. TRANSVERSE SAW CUT EVERY 3000 OR AT PAVEMENT JOINTS AND TO  
BE REINFORCED WITH 19.1mm DOWELS 450 LONG AS SHOWN ABOVE.



**THE CITY OF WINNIPEG**  
PUBLIC WORKS DEPARTMENT

DIMENSIONS ARE IN MILLIMETRES

CURB AND GUTTER

Reference Spec. No.  
CW 3240, CW 3310

Scale :  
N.T.S.

Approved:  
R.O.W. MANAGEMENT TEAM

Drawing No.  
CD-13

# Appendix N: Concrete Sidewalk

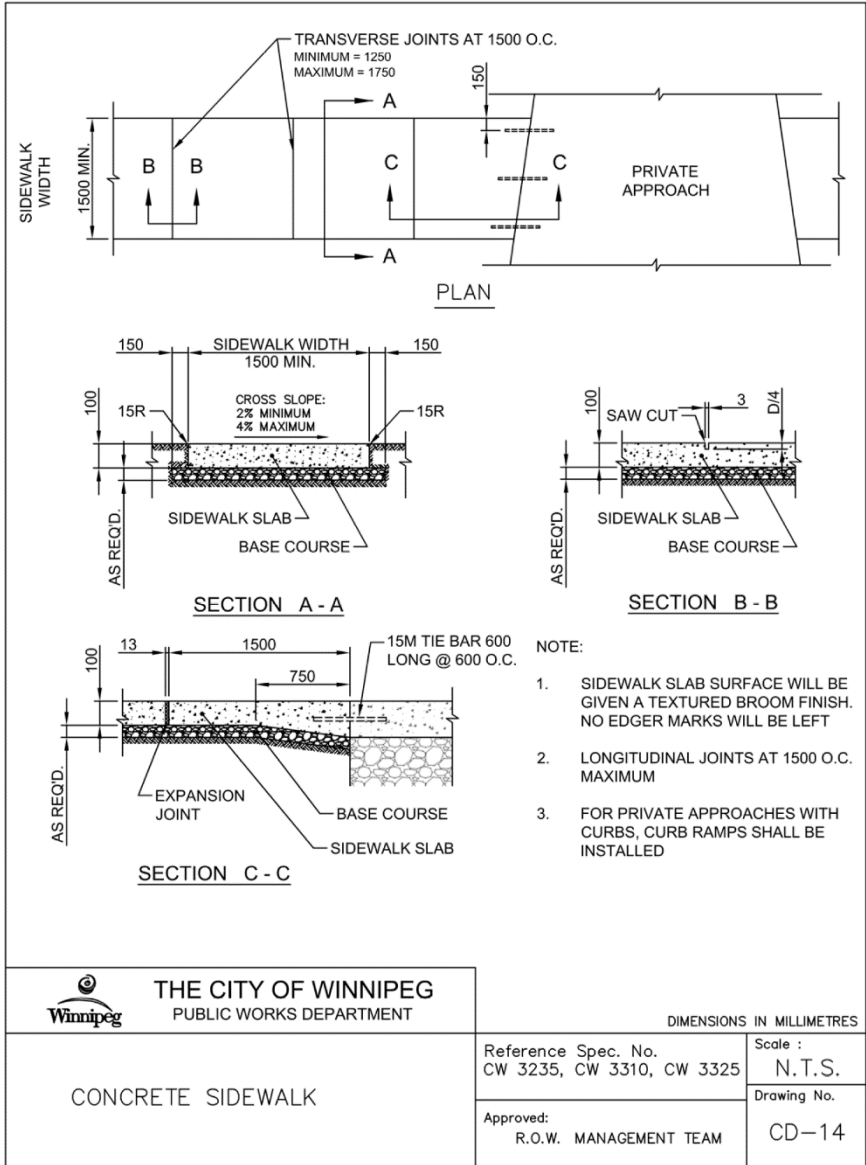

**THE CITY OF WINNIPEG**  
PUBLIC WORKS DEPARTMENT

DIMENSIONS IN MILLIMETRES

CONCRETE SIDEWALK

Reference Spec. No.  
CW 3235, CW 3310, CW 3325

Scale :  
N.T.S.

Approved:  
R.O.W. MANAGEMENT TEAM

Drawing No.  
CD-14

## Appendix O: Protection of Trees

- The Contractor shall not stockpile materials and soil, or park vehicles and equipment on boulevards within two (2) metres of trees.
- Trees identified to be at risk by the Designated Employee are to be strapped with 25 x 100 x 2400mm wood planks, or suitably protected as approved by the Designated Employee.
- Excavation shall be performed in a manner that minimizes damage to the existing root systems. Where possible, excavation shall be carried out such that the edge of the excavation shall be a minimum of 1.5 times the diameter (measure in inches), with the outcome read in feet, from the closest edge of the trunk. Where roots must be cut to facilitate excavation, they shall be pruned neatly at the face of excavation.
- Operation of equipment within the dripline of the trees shall be kept to the minimum required to perform the work required. Equipment shall not be packed, repaired, refueled; construction materials shall not be stored, and earth materials shall not be stockpiled within the driplines of trees. The dripline of a tree shall be considered to be the ground surface directly beneath the tips of its outermost branches. The Contractor shall ensure that the operations do not cause flooding or sediment deposition on areas where trees are located.
- Work on-site shall be carried out in such a manner so as to minimize damage to existing tree branches. Where damage to branches does occur, they shall be neatly pruned.

## LINKS

- The City of Winnipeg's **Streets By-Law No. 1481/77** and list of Regional Streets available at:

<https://clkapps.winnipeg.ca/dmis/docext/ViewDoc.asp?DocumentTypeId=1&DocId=304>

- The City of Winnipeg's **Manual of Temporary Traffic Control on City Streets** available at:

<https://legacy.winnipeg.ca/publicworks/transportation/pdf/2022-ManualOfTemporaryTrafficControl.pdf>

- The City of Winnipeg's **Standard Construction Specifications** including approved product and concrete suppliers available at:

<https://legacy.winnipeg.ca/matmgt/spec/default.stm>

- The City of Winnipeg's **Street Conditions** map available at:

<https://legacy.winnipeg.ca/publicworks/maps/streetconditions.asp>

- The City of Winnipeg's **Regional Street Network** map available at:

<https://legacy.winnipeg.ca/publicworks/trafficControl/pdf/regionalStreetNetwork-MAP.pdf>









# CITY AREA BOUNDARIES

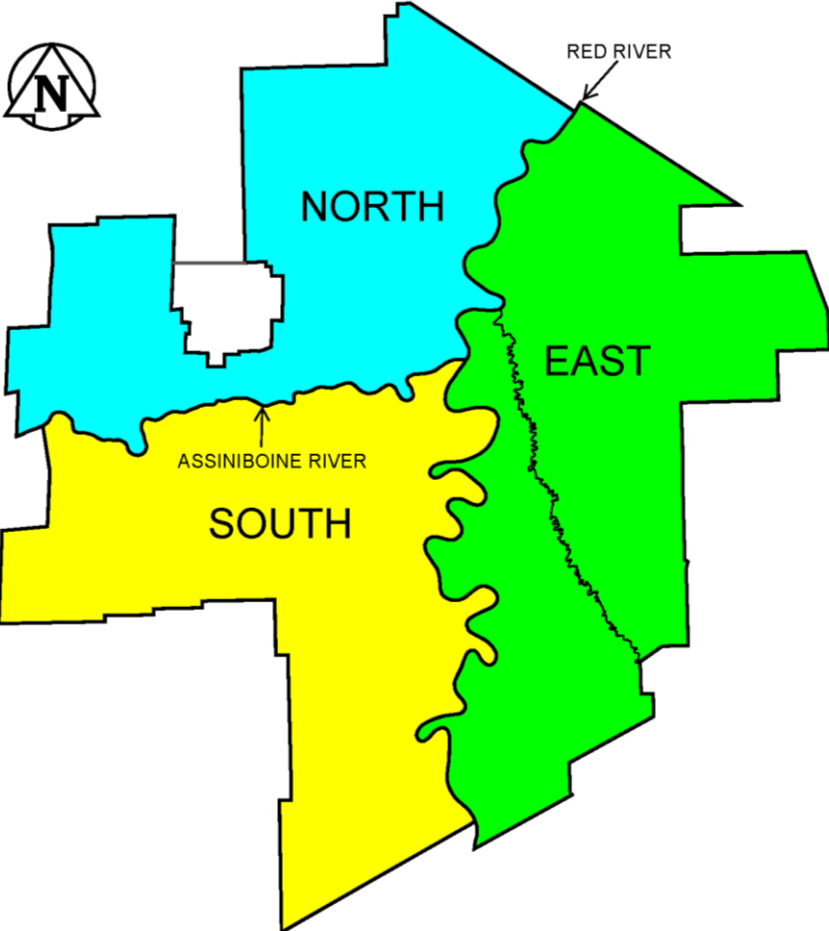

## CONTACTS

### **Supervisor of Right-of-Way Management**

Alex Tarasov, C.E.T.

Email: [OTarasov@winnipeg.ca](mailto:OTarasov@winnipeg.ca)

### **Senior Boulevard Cut Inspector**

Jessica Wyborn

Email: [JWyborn@winnipeg.ca](mailto:JWyborn@winnipeg.ca)

### **North Area Cut Inspector**

Email: [Pwd-N-Cut@winnipeg.ca](mailto:Pwd-N-Cut@winnipeg.ca)

### **East Area Cut Inspector**

Email: [Pwd-E-Cut@winnipeg.ca](mailto:Pwd-E-Cut@winnipeg.ca)

### **South Area Cut Inspector**

Email: [Pwd-S-Cut@winnipeg.ca](mailto:Pwd-S-Cut@winnipeg.ca)

### **Street Cut Permit Clerks**

Email: [pwdcspermits@winnipeg.ca](mailto:pwdcspermits@winnipeg.ca)

Phone: 207-986-3184

### **Underground Structures**

Email: [ugsapproval@winnipeg.ca](mailto:ugsapproval@winnipeg.ca)

### **Traffic Management Branch**

Email: [PWDLaneClosures@winnipeg.ca](mailto:PWDLaneClosures@winnipeg.ca)

### **General Inquiries – Customer Service**

Email: [311@winnipeg.ca](mailto:311@winnipeg.ca)\*

\*This email contact will be phased out during 2024, please consider using one of the following options:

- Online: [winnipeg.ca/311-city-services](http://winnipeg.ca/311-city-services)
- Phone: 311 or 1-877-4974 (outside Winnipeg)
- Facebook/Twitter: @cityofwinnipeg



**Public Works  
Travaux publics**