

Pools and Hot Tubs/Spas



Construction information



Permit requirements

In-ground or above-ground pools, hot tubs/spas or any other structure located outdoors capable of containing 600 mm (2'-0") or more of water require a building permit.

A development permit is required if the structure is located next to a storm water retention basin or is in the Designated Floodway Fringe Area. A development permit establishes land use and confirms the structure is located on the property in accordance with the zoning bylaw and other City departments' requirements. For more information on development permit exemptions, visit winnipeg.ca/developmentpermits.

A building permit confirms the structure meets code requirements. Building permits must align with prior development permit approvals.

Table of contents

Permit requirements 1
Zoning requirements 3
Electrical requirements 4
Fencing requirements 5
Gate requirements 7
Additional considerations 10

Note

The primary intent of the regulations concerning pools and hot tubs/spas is to minimize the danger that they present for small children. When in doubt, please side with caution.

The Winnipeg Building By-law is primarily an administrative document that adopts the Manitoba Building Code and related standards to provide construction regulations.

Throughout this publication the Manitoba Building Code will be referred to as the Building Code.

Mandatory Inspections

Housing inspections can be booked by completing the Housing Inspection Request Form at winnipeg.ca/housinginspection (preferred method) or by calling the Housing Inspections office at 204-986-5300 between 8:30 a.m. and 4 p.m., Monday to Friday. Please be aware that wait times vary for phone-in requests.

Mandatory inspections are as follows:

1. Once the bonding of all metal components (including rebar if there is a concrete base) has been completed including trench inspections for underground wiring; and
2. Before putting more than 600 mm (2'-0") of water in the pool – inspection availability varies so try to book ahead if possible. All fencing and gates need to be complete prior to this last inspection.

All hot tub inspections must have the access cover opened prior to the inspector’s arrival.

All installation manuals and relevant documentation must be provided to the inspector at the time of inspection.

Temporary construction fencing may be required where there is an open excavation, or more than 600 mm (2'-0") of water in the pool. Temporary or permanent fencing must meet the minimum requirements listed in this document at all stages of construction.

Zoning requirements

The City of Winnipeg Zoning By-law requires locating your pool maintaining certain minimum setbacks from your property line. For in-ground pools, see **Figure 1**. For above-ground pools, see **Figure 2**. If you plan to construct a covered structure over the in-ground or above-ground pool, additional zoning requirements will apply. For more information, contact Zoning.

If you plan to construct a deck around an above-ground pool you may require a minimum 7.6 m (25'-0") rear yard setback. (For more information, refer to the Decks brochure.)

Figure 1: In-ground pools

- a - front yard - same as principle building
- b - side yard - 1.5 m (5'-0")
- c - reverse corner yard - same as principle building
- d - rear yard - 1.5 m (5'-0")

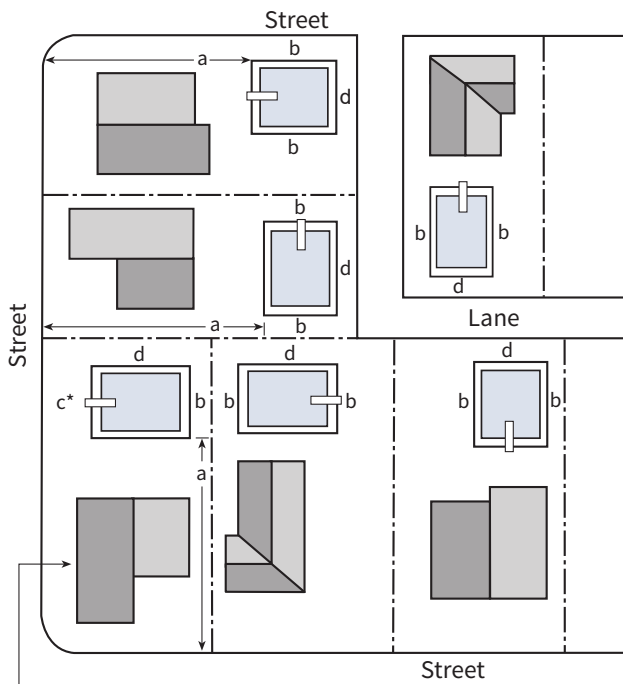

* a reverse corner lot is a corner lot where its rear property line abuts the side lot line of an adjoining property

Figure 2: Above-ground pools

- a - 600 mm (2'-0")
- b - 600 mm (2'-0")
- c - same as dwelling - usually 1.2 m (4'-0")
- d - same as dwelling - usually 2.7 m (9'-0")
- e - 18 m (60'-0") to front property or behind rear wall of dwelling, whichever is greater

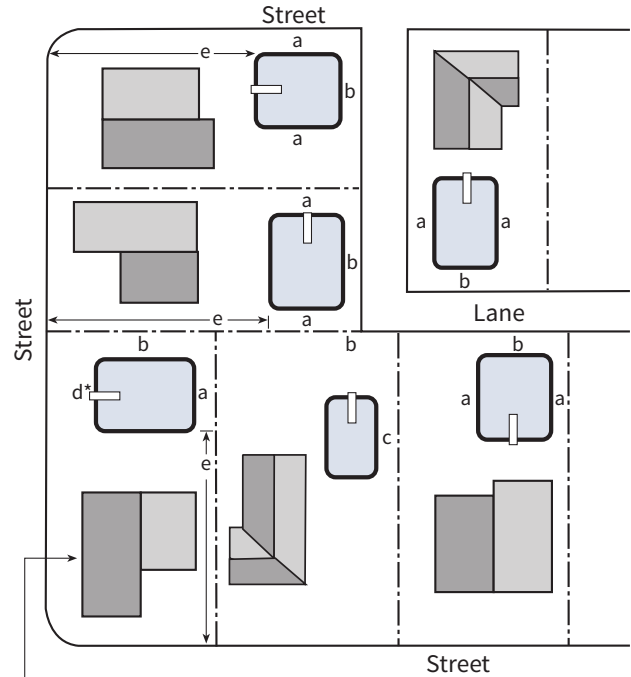

* a reverse corner lot is a corner lot where its rear property line abuts the side lot line of an adjoining property

Pool heaters and pumps may be located beside or behind your house as long as they are not closer than 3 m (10'-0") to an openable window of a habitable room in your neighbour's house and are at least 600 mm (2'-0") from a property line.

Front yard installations may be permitted subject to appropriate landscaping.

Certain gas heaters and chimneys may have restrictions on their location based on a minimum distance from nearby combustible materials. Consult with your gas utility company with regard to gas installation codes, which may apply.

If you cannot meet the zoning requirements, you must apply for a zoning variance.

Electrical requirements

An electrical permit is required for the connection of electrical equipment associated with the pool, including bonding of metal parts. For more information, please view our Information Bulletin on pool bonding permit requirements at:

winnipeg.ca/ppd/infocentre/informationbulletins.stm

If you are building a pool below overhead utility conductors of 750 volts or less (including electrical utility wires and telecom wiring), a minimum clearance of 5 m (16'-6") must be maintained between the overhead conductors and the top of the pool for an area extending 5 m (16'-0") horizontally from each pool edge (see **Figure 3**). The minimum clearance for any diving structure, slide or observation stand incorporated into a pool design would be measured from the top of the vertical structure.

No conductors are permitted in the area under Line 1 in the diagram below.

For high voltage power supply conductors exceeding 750 volts and specific requirements associated with underground wiring close to pools, please refer to the Winnipeg Electrical By-law or contact the Housing Inspections Branch at 204-986-5300.

All metal parts of a pool and other non-electrical equipment associated with the pool and its base including piping, reinforcing steel, ladders, diving board supports, etc., must be bonded in accordance with the requirements of the City of Winnipeg Electrical By-law.

The bonding conductor shall be #6 AWG copper and run to the panel board supplying pool equipment.

Electrical receptacles and light fixtures must be Class A ground fault circuit interrupter (GFCI) protected in accordance with the Winnipeg Electrical By-law.

Utility metering equipment cannot be closer than 3 m (10'-0") to any pool unless suitably separated by a permanent barrier.

Existing electrical installations where the conditions have been changed due to the addition of any pool may require alteration to achieve Code compliance.

Refer to winnipeg.ca/electricalinstallations for more information.

Figure 3: Overhead conductors less than 750 volts

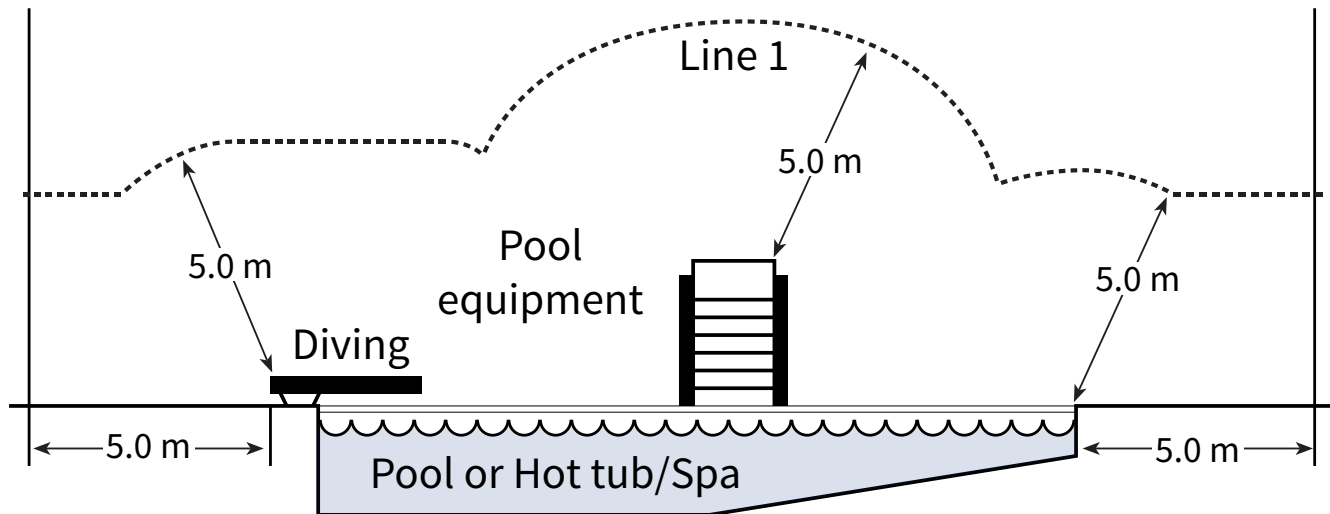

Fencing requirements

All outdoor pools must be completely enclosed by a non-climbable fence or other suitable barrier constructed in accordance with the following requirements:

- it must have a minimum vertical height of 1.5 m (5'-0") and a maximum vertical height of 2.0 m (6'-6");
- there must not be more than 100 mm (4 in.) between the bottom of the fence and the ground;
- there must be no openings, other than a door to a building or a gate, and it must not be possible for a child to crawl under either the fence or the gate;
- where chain link is used, the mesh size must not exceed 50 mm (2 in.) and the wire must be at least number 11 gauge;
- where other than chain link is used, the outside surface of the fence or gate must be relatively smooth so as not to provide foot or toe holds;
- it is not permitted to fill the pool with more than 600 mm (2'-0") of water before the fencing has been completed. Temporary fencing is required until permanent fencing is in place.
- if, in the opinion of the authority having jurisdiction, there is any undesirable feature pertaining to the enclosure, suitable steps must be taken to correct the situation.

Note: Above ground pool safety ladders must satisfy Building Code 10.1.2. code requirements for fencing and pool gates if being used in lieu of fencing and gates.

The illustrations below are suggestions for meeting the construction requirements for pool fences. Other alternatives may be used provided they meet the intent of the Building Code.

Vertical board (picket)

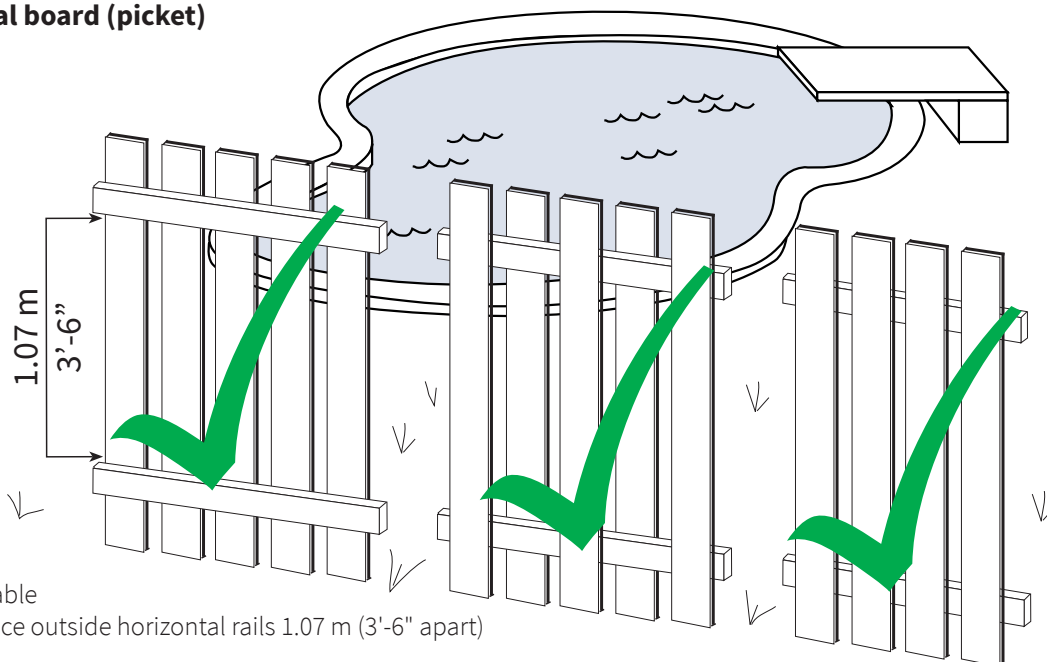

Acceptable

- Place outside horizontal rails 1.07 m (3'-6" apart)

For hot tub/spa installations in a single-family dwelling, the fence requirements may be omitted provided the cover meets the following conditions:

1. The cover is not greater than 2.4 m (94.5") in diameter or 4.65 m² (50 sq. ft.) in area*.
2. The cover is lockable to prevent access.
3. The cover can support the weight of an adult in the closed position.

*Please note that due to the size of the cover, swim spas may not comply with the exemption to omit fencing.

Not acceptable

- When building this type of fence, avoid closely spaced horizontal rails.
- The fence shall not be climbable from the exterior of the property into the property containing the pool.
- Alterations to an existing fence may be required in order to be accepted as non-climbable.
- Where the fence is shared or owned by a neighbour, the pool owner shall be responsible for meeting the requirements.

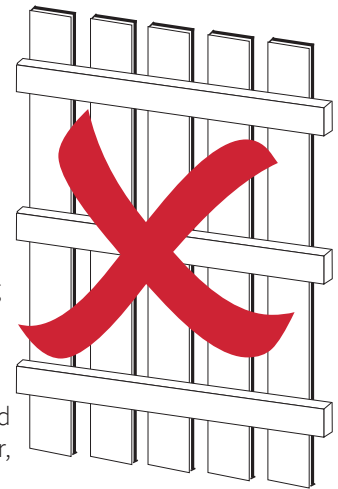

Wooden lattice and horizontal board

Maximum openings
50 mm (2 in.)

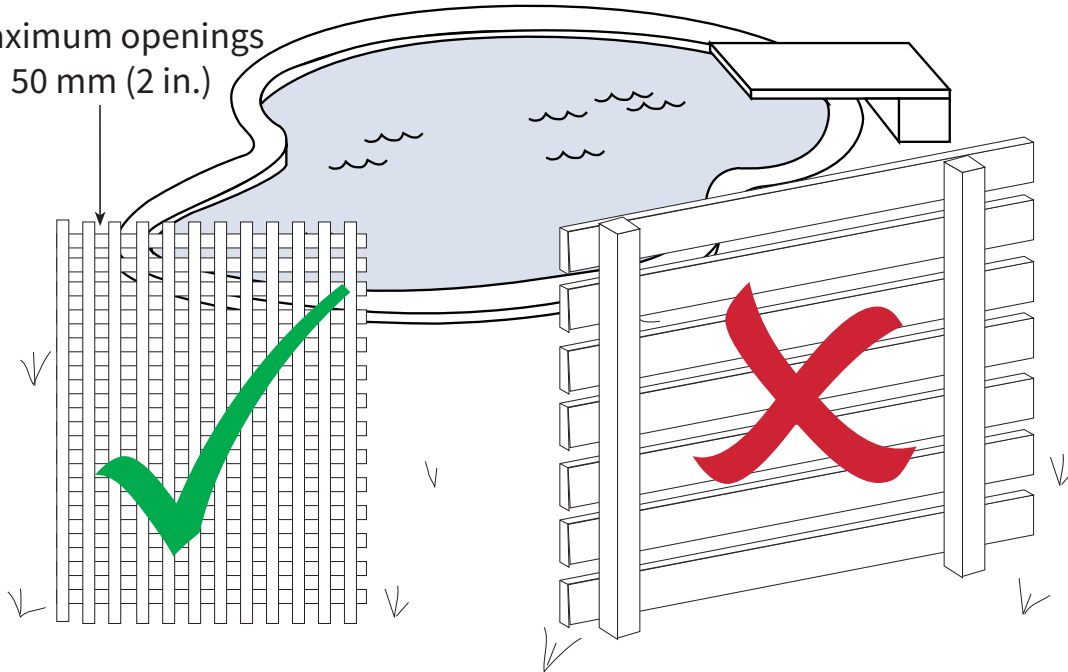

Acceptable

- Place horizontal straps on the inside of the fence

Not acceptable

- There can be no more than 0.5 in. space between horizontal boards

Wrought iron

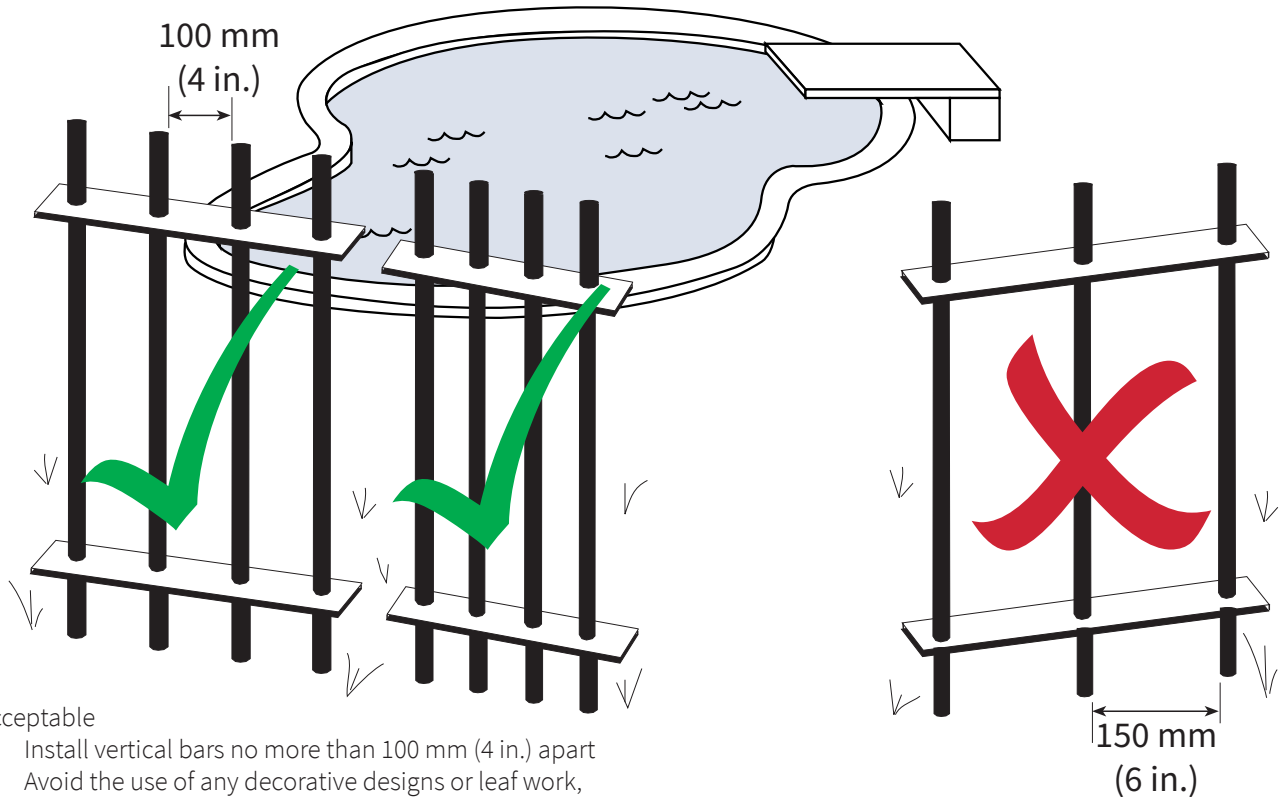

Acceptable

- Install vertical bars no more than 100 mm (4 in.) apart
- Avoid the use of any decorative designs or leaf work, which could provide foot or toe holds
- Install the latching in a fashion that cannot be easily reached through the wrought iron

Not Acceptable

- Bars too far apart

Gate requirements

All gates must be self-closing, at least 1.5 m (5'-0") in height, and must have a self-latching, lockable latch to prevent unauthorized entry into the pool area.

Self-closing, permanently installed devices that will cause the gate to return to a closed and latched position without the aid of a push or pull are required on all gates in a pool fence. Self-closing devices must be maintained in good repair and functioning as designed at all times.

The use of vehicle gates as part of the pool enclosure is not recommended. These gates are often too large and too heavy to be automatically closed with most existing hardware. Pairs of gates are also discouraged unless they can be made to close and latch automatically.

Illustrated below are three commonly used types of closers designed to close the gate automatically.

1. Torsion spring Pushes gate closed

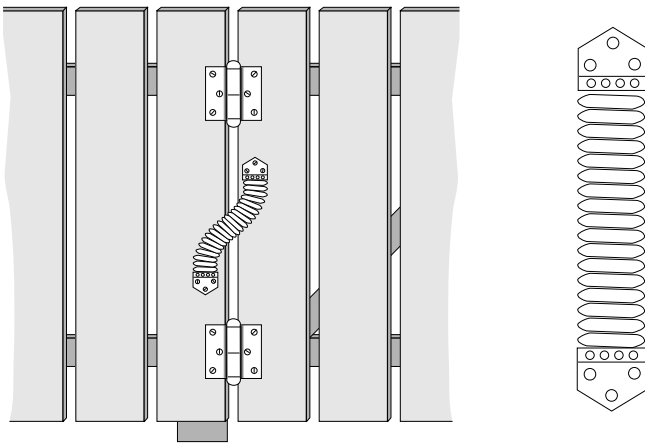

2. Spring loaded hinges Pushes gate closed

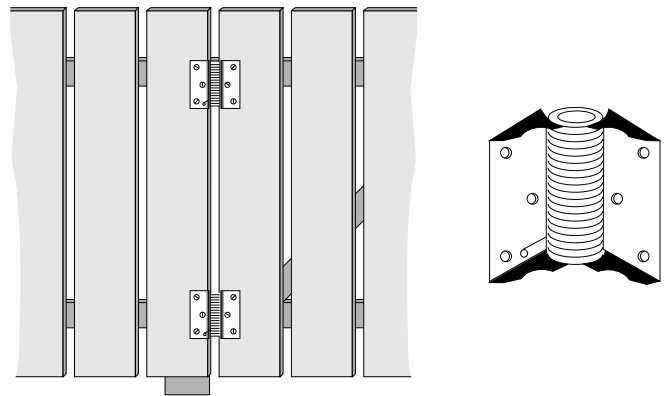

3. Hydraulic closer Pushes gate closed

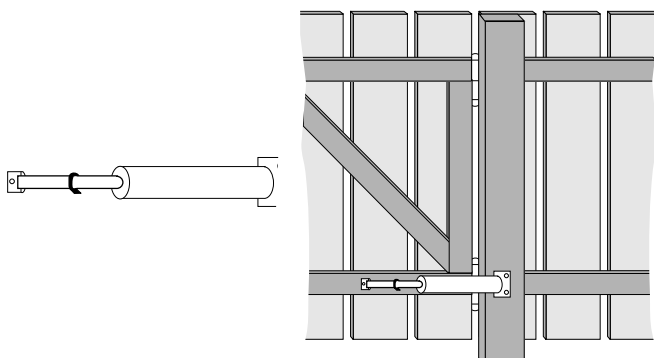

Automatic latches

Automatic latches that become secured upon contact with the closing gate are required on all gates in a pool fence. Some commonly used types are illustrated below.

Tongue latch

Padlocks on gates are recommended when pools are left unattended

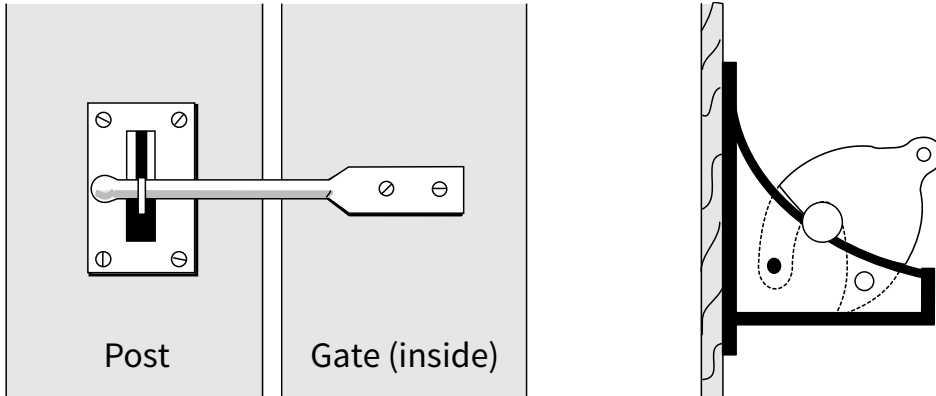

Sliding bar thumb latch

This type of latch is often installed too low. It should be at a height of 1.37 m (4'-6") minimum.

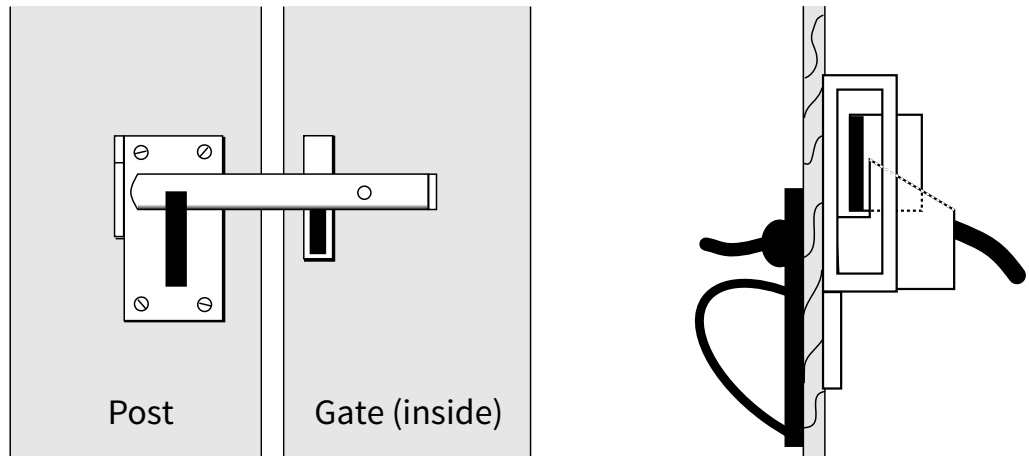

Key latch

This type of latch is spring loaded.

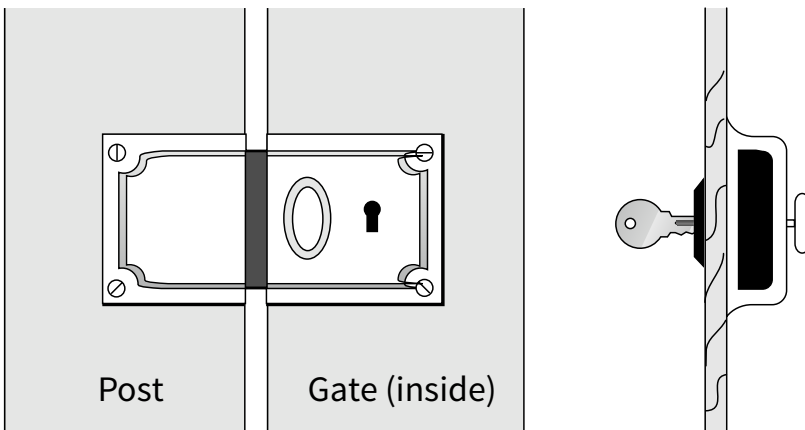

Example of a self-closing/automatically latching gate

If a latch cannot be installed on the inside of the gate, install it at a safe height at the top of the gate where it cannot be easily reached by younger persons.

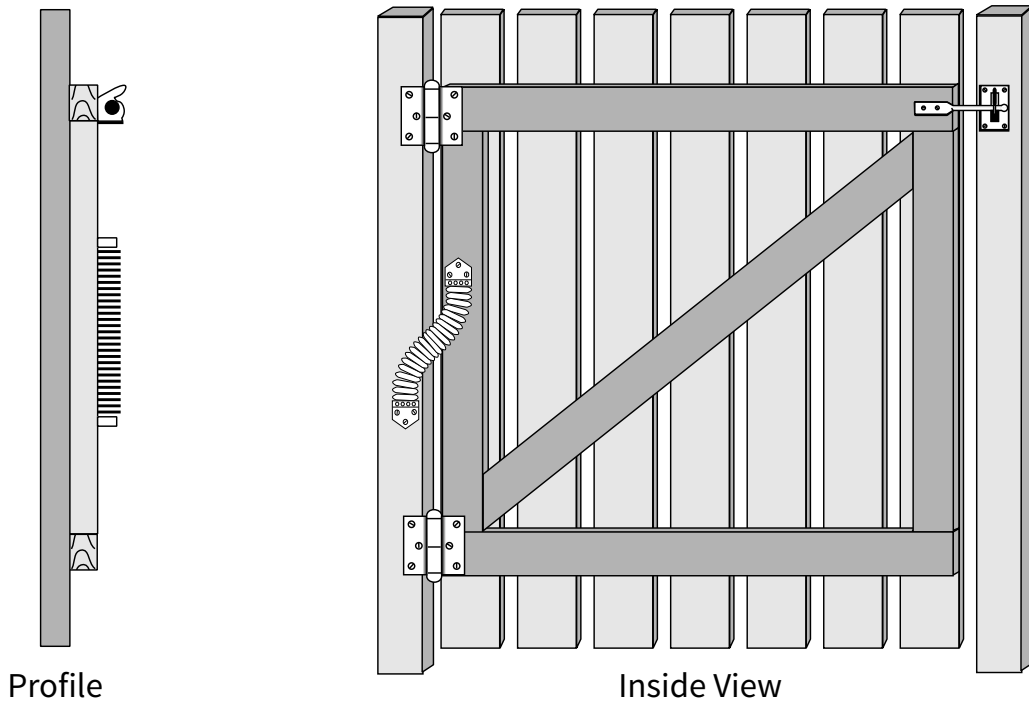

Unacceptable latch

- This latch has to be manually engaged.
- It could impair the gate from self-closing and securing.

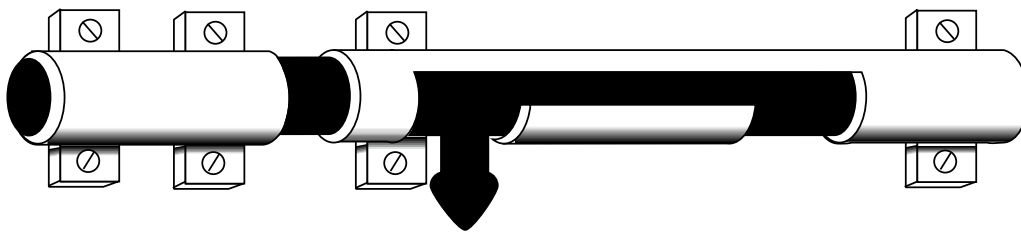

Remember

These requirements are intended to prevent unauthorized entry of those persons too young to understand the dangers of a pool.

Additional considerations

Drainage

The City of Winnipeg Sewer By-law No. 92/2010 requires that the discharge of water from pools must be to the wastewater sewer system. Pool water and/or pool filter backwash water must not be discharged onto any street, lane, lake or drainage ditch. The wastewater sewer in the house may be utilized by draining, pumping, or back washing filters into the floor drain or catch basin in the basement of your house.

Pool water may also be discharged by having it removed for disposal by a licenced wastewater hauler, or it can be discharged onto your property if the water remains within the property until it evaporates or soaks into the ground.

For additional information on draining a pool, please see the Water and Waste Department website:

winnipeg.ca/waterandwaste/sewage/drainpool.stm

Owner's responsibilities

It is the responsibility of the property owner to ensure that these regulations are met, in particular that the fencing is in good repair and that the pool area is securely maintained at all times.



Planning, Property & Development
Urbanisme, biens et aménagement

Zoning & Permits Branch

Unit 31 - 30 Fort Street, Winnipeg, Manitoba R3C 4X7 | winnipeg.ca/ppd

Permits Direct Line

204-986-5140 | ppd-permit@winnipeg.ca

Updated: March 2024

Every effort has been made to ensure the accuracy of information contained in this publication. However, in the event of a discrepancy between this publication and the governing City of Winnipeg By-law, the bylaw will take precedence.